

SoClean³

Automated Supplemental Sleep Equipment Maintenance System

SoClean³

Contact Customer
Care to setup
and activate
your SoClean³.

844-201-2483

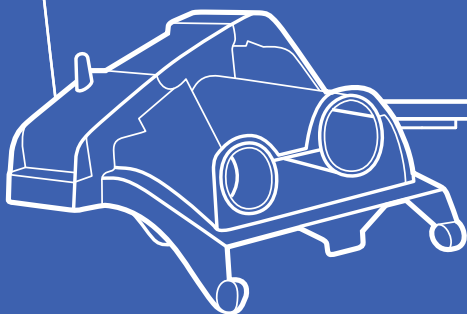

USER MANUAL
FOR USE WITH THE RESMED AIRSENSE 10

Manual en español | [SoClean.com/3-es](https://www.soclean.com/3-es)
SC1400



You must call Customer Care to setup and activate your device.

844-201-2483

TABLE OF CONTENTS

Overview	3
Warnings and Precautions	6
Learn About Ozone	9
Your Cleaning & Maintenance Regimen	10
Setting Up Your SoClean 3	11
Washing Your Sleep Equipment Accessories	20
Using Your SoClean 3	22
Your SoClean 3: Parts & Icons	33
Maintenance	42
General Troubleshooting	44
Warranty Information	50



OVERVIEW

Indications for Use, Contraindications, and Specifications

INDICATIONS FOR USE

The SoClean 3 device is intended to be used to supplement cleaning procedures as part of sleep equipment maintenance in the home.

CONTRAINDICATIONS FOR USE

Persons with underlying lung diseases, such as asthma and chronic obstructive pulmonary disease (also known as COPD, which includes emphysema and chronic bronchitis), and those with cardiovascular disease may be sensitive to ozone and should consult with their health care professional before using this product.

CAUTION: Safety in pregnant or breastfeeding women and children under the age of 22 have not been established. Consult with your health care professional before using this product.

Read this instruction manual before operating this device.

The SoClean 3 device should be used only according to the procedures described in this manual. If it is used in a manner not specified by SoClean®, the safety protection provided by the equipment may be impaired.

SPECIFICATIONS

Model Number

SC1400

Operating Environmental Conditions

Indoor use only.

Temperature: 50°F to 100°F (10°C to 38°C)

Relative Humidity: 15% to 75%

Altitude: sea level to 8,500' (2,591 m);

Air Pressure Range 101.3 kPa to 73.8 kPa

Physical Characteristics

Dimensions: 9.49" x 7.12" x 7.36"

(241 x 181 x 187 mm)

Weight: 3.65 lbs. (1.65 kg), Cord Length: 4' 11"

Electrical Characteristics

AC Adapter Input: AC 100~240V, 50/60HZ, 0.5A

AC Adapter Output: DC 12V, 1.5A Max

Power Consumption: 18W Max

USB Charging Port Output: DC 5V, 0.5 A Max

Storage and Transport Conditions

Temperature: -4°F to 131°F (-20°C to +55°C)

Humidity: 15% to 95% non-condensing humidity

Pressure: 106kPa to 70kPa

[Sea level to 10,000' (3048m)]

Ozone Cycle

75 minutes

Ozone Concentration

440 ppm maximum from ozone generator

Electromagnetic Compatibility

The SoClean 3 complies with all applicable electromagnetic compatibility requirements (EMC) according to IEC 60601-1-2:2014, for residential, commercial, and light industry environments. If electrical interference is suspected during operation, contact SoClean Customer Care.

Sleep Equipment Operating Sound Level

Average ResMed AS10 operating sound pressure level and power level of 38 dBA when configured for use with the SoClean 3 and measured at 1 meter. Measurement in accordance with ISO 4871:1996.

Sleep Equipment Hose Dimensions Compatibility

For use with hose diameters of 15 mm inner diameter (18-19 mm outer diameter) and length up to 6' 6". A 12 mm hose requires use with the SoClean Hose Sleeve.

USB Port

This port is provided only for USB charging. No data is provided on this port.









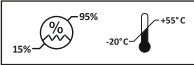

Maximum USB charging cord length: 10 ft. (3 m).

OVERVIEW

OZONE LEAKAGE

The SoClean 3 meets 21 C.F.R. § 801.415 for the maximum allowable ozone accumulation of not more than 0.05 parts per million when operated in a room larger than 70 square feet with 8-foot or higher ceilings.

PACKAGING SYMBOLS

 Consult Manual	 Do Not Use If Package Is Damaged	 No Liquid in SoClean Chamber	 Storage and Transport Conditions
 Serial Number	 Not Made With Natural Rubber Latex	 General Caution	 Federal Communications Commission
 General Warning	 Date of Manufacture	 Waste Electrical and Electronic Equipment (WEEE). It is the responsibility of the end user to dispose of this equipment at a designated collection point.	

DISPOSAL INFORMATION: Safe disposal of the device: Follow the local, state, and national governing ordinances and recycling instructions regarding disposal or recycling of the device and device components at the end of the expected service life.

FCC Notice Part 15:

This device complies with part 15 of the FCC rules. Operation is subject to the following two conditions: (1) This device may not cause harmful interference, and (2) this device must accept any interference received, including interference that may cause undesired operation.

NOTE: This equipment has been tested and found to comply with the limits for a class B digital device, pursuant to part 15 of the FCC rules. These limits are designed to provide reasonable protection against harmful interference in a residential installation. This equipment generates, uses, and can radiate radio frequency energy and, if not installed and used in accordance with the instructions, may cause harmful interference to radio communications. However, there is no guarantee that interference will not occur in a particular installation. If this equipment does cause harmful interference to radio or television reception, which can be determined by turning the equipment off and on, the user is encouraged to try to correct the interference by one or more of the following measures:











- Reorient or relocate the receiving antenna.
- Increase the separation between the equipment and receiver.
- Connect the equipment into an outlet on a circuit different from that to which the receiver is connected.
- Consult SoClean Customer Care for help.

 **FCC CAUTION:** Changes or modifications not expressly approved by the party responsible for compliance could void the user's authority to operate the equipment.

 **CAUTION:** This equipment complies with FCC/IC RSS-102 radiation exposure limits set forth for an uncontrolled environment. To maintain compliance with the FCC and IC RF exposure guidelines, place the unit at least 20 cm away from nearby persons.



Warnings and Precautions

-  **WARNING:** Discontinue use and call your health care professional in the event that you experience any respiratory or cardiac symptoms.
-  **WARNING:** Keep away from children.
-  **WARNING:** When operating the SoClean 3 per the instructions for use and a strong ozone odor (sweet chlorine-like smell) is detected, inspect for visible damage, such as cracks in the enclosure or tubing along with tubing connections. If you believe the SoClean 3 device is not operating correctly, disconnect the power to the device and contact SoClean.
-  **WARNING:** Ensure sleep equipment hose and SoClean Adapter are connected to the sleep equipment machine prior to operating a SoClean 3 Cycle.
-  **WARNING:** Do not inhale from the Ozone Tube or the Ozone Outlet on the back of the device. Do not breathe through the mask if the SoClean 3 is operating a Maintenance Cycle.
-  **WARNING:** Do not forcibly open the SoClean 3 Lid before the Cycle completes.
-  **WARNING:** Do not submerge the SoClean 3 device in water or use chemical cleaners on or in your SoClean 3. Keep away from water sources, including rain, bathtubs, sinks, and pools. To clean, wipe inside and outside with a damp cloth.
-  **WARNING:** Do not put Neutralizing Pre-Wash or water into the SoClean Chamber. Do not use the Neutralizing Pre-Wash on or in the SoClean 3 device. The Pre-Wash is intended for washing sleep equipment accessories only.
-  **WARNING:** Do not disassemble or modify your SoClean device or accessories.
-  **WARNING:** If the SoClean system is dropped, it may become damaged. Especially after the system has been dropped, regularly inspect the SoClean 3 for physical damage, such as cracks or broken structure, damaged gaskets, and cracks in the Ozone Tube or sleep equipment hose. Discontinue use if damage is detected and contact SoClean for assistance.
-  **WARNING:** To reduce the chance of tripping, place your sleep equipment and SoClean along with all cords, tubes and hoses out of the way of any area you may walk.



WARNING: The **Ozone Tube** should always be connected to the SoClean Adapter and the back of the SoClean 3 unit when operating the SoClean 3.

Contraindication: Persons with underlying lung diseases, such as asthma and chronic obstructive pulmonary disease (also known as COPD, which includes emphysema and chronic bronchitis), and those with cardiovascular disease may be sensitive to ozone and should consult with their health care professional before using this product.

-  **CAUTION:** Do not place any flammable or ignitable items on top of the SoClean 3 device. Do not use in explosive air environments, near gas vapors, or other flammables, etc.
-  **CAUTION:** Do not run the sleep equipment machine during the SoClean 3 Cycle.
-  **CAUTION:** In the event of a SoClean 3 failure during operation, run the sleep equipment device for 5 minutes to blow air through and remove the potential of ozone from the sleep equipment airway prior to putting on the mask and breathing through the sleep equipment airway.
-  **CAUTION:** Discontinue use of your SoClean 3, consult your health care professional, and contact SoClean Customer Care if acne or a rash develops along the mask contact line.
-  **CAUTION:** Ensure all tubing and hoses are free of kinks prior to operating the SoClean 3.
-  **CAUTION:** Rest the flexible part of the sleep equipment hose, not the rigid mask connector, in the Hose Slot to ensure a proper seal.
-  **CAUTION:** Inspect the SoClean 3 Lid and Hose Gasket for visible damage before operating a Maintenance Cycle.
-  **CAUTION:** In the event of a sleep equipment failure that prevents sleep therapy, disconnect the SoClean 3 from the sleep equipment and restore the original sleep equipment factory configuration. Contact SoClean Customer Care if the error clears.
-  **CAUTION:** Use SoClean 3 with only one sleep equipment user and a single mask and hose.
-  **CAUTION:** In the event of loss of power, rerun the entire Maintenance Cycle to make sure the sleep equipment accessories have been maintained properly.
-  **CAUTION:** Use the Neutralizing Pre-Wash or unscented mild detergent to wash your sleep equipment accessories according to the sleep equipment manufacturer's recommended method and interval. Use the SoClean 3 for daily supplemental maintenance of your sleep equipment accessories.
-  **CAUTION:** Do not use incompatible materials in the SoClean 3 such as memory foam, natural rubber and nylon, as noticeable degradation of the materials may occur.
-  **CAUTION:** The SoClean 3 has not been tested for compatibility with sleep equipment machines that are not listed in this manual. Contact SoClean for the status of compatibility with additional sleep equipment. (See pages 7 & 8)

COMPATIBLE SLEEP EQUIPMENT MACHINES, ADAPTERS, AND ACCESSORIES

Sleep equipment machines require adapters and are available from SoClean.com. If adapters were not included with your SoClean 3, contact your authorized reseller or SoClean.com.

SLEEP EQUIPMENT HOSE COMPATIBILITY

For use with hose diameters of 15 mm inner diameter (18-19 mm outer diameter) and length up to 6' 6". A 12 mm hose requires use with the SoClean Hose Sleeve.

MATERIAL COMPATIBILITY

Sleep equipment accessories are made from a variety of materials and SoClean has tested sleep equipment masks and hoses for material compatibility with the ozone maintenance process.

While most sleep equipment accessories are made of compatible materials, the following materials should not be used with the SoClean 3: memory foam, natural rubber and nylon. For a complete list of ozone compatible materials visit SoClean.com.

Sleep equipment accessory materials age and discolor naturally over time and with use, which is why the sleep equipment accessory manufacturers recommend replacing these components at regular intervals. Testing with the SoClean 3 shows sleep equipment accessories are safe and functional despite any potential discoloration, when used per the manufacturer's instructions and replacement intervals.

CAUTION: Do not use incompatible materials in the SoClean 3 such as memory foam, natural rubber and nylon, as noticeable degradation of the materials may occur.

Sleep equipment manufacturers introduce new sleep equipment accessories over time. Contact SoClean for the most current list of compatible accessories.

How does my SoClean 3 Work?

Learn About Ozone

SoClean 3 uses Activated Oxygen, also known as ozone. Ozone contacts the Sleep equipment accessories only, not the user, during the Maintenance Cycle. **The scent of ozone has the characteristic of a sweet chlorine-like smell.**

SoClean 3 is designed to produce a sufficient level of ozone for maintenance of your sleep equipment accessories. The smell of ozone is detectable at low concentrations by some people and you may smell ozone briefly during the Maintenance Cycle.

Ozone quickly dissipates in the atmosphere. The SoClean 3 device is designed to safely contain ozone within the system. It has a Filter inside the Maintenance Chamber to help convert ozone back to oxygen.

Should you detect an unusually strong scent of ozone or experience respiratory irritation during SoClean operation, unplug your SoClean unit, seek fresh air and contact SoClean for customer support before continued use.

⚠ WARNING: If the SoClean system is dropped, it may become damaged. Especially after the system has been dropped, regularly inspect the SoClean 3 for physical damage, such as cracks or broken structure, damaged gaskets, and cracks in the Ozone Tube or sleep equipment hose. Discontinue use if damage is detected and contact SoClean for assistance.

NOTE: Any serious incident that has occurred in relation to the device should be reported to SoClean.

⚠ CAUTION: Discontinue use of your SoClean 3, consult your health care professional and contact SoClean Customer Care if acne or a rash develops along the mask contact line.

Your Cleaning & Maintenance Regimen

The SoClean 3 can be used to supplement the regular washing interval of your sleep equipment accessories with daily maintenance.

What is the difference between washing and maintaining?

Washing is needed to remove residue like oils, films, debris and other build up that can naturally form on your equipment from use. Maintenance is meant to be a supplement to the hand washing process.



1 Wash your hose and mask in the sink per manufacturer's recommendations. Washing removes oils, films, debris and other build up that can naturally form on your equipment from use.

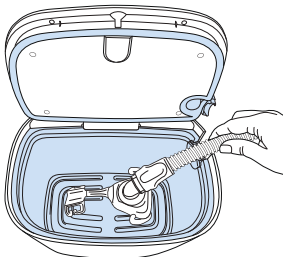

2 Supplement regular washing by using the SoClean 3 to maintain your mask and hose daily.

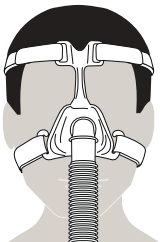

3 Use your sleep equipment as prescribed.

Go to page 22 for Using Your SoClean

Setting Up Your SoClean 3



You must call Customer Care to
setup and activate your device.

844-201-2483

POWERING YOUR SOCLEAN 3



A **Power Supply** is provided to safely power your SoClean 3. You will need access to 1 AC outlet near your SoClean 3/sleep equipment to power your SoClean 3.

- 1 Locate an AC wall outlet near your sleep equipment/ SoClean 3 setup.

NOTE: It is okay to plug into a power strip, if needed.



WARNING: Avoid tripping hazard.

- 2 Locate your **Power Supply** in the Welcome Kit as shown. Remove the **Power Supply** and **Plug Adapters** from the box. Select the correct **Plug Adapter** and insert it into the **Power Supply** base until it clicks into place.

Power Supply

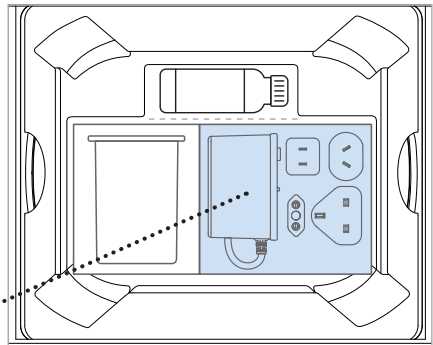

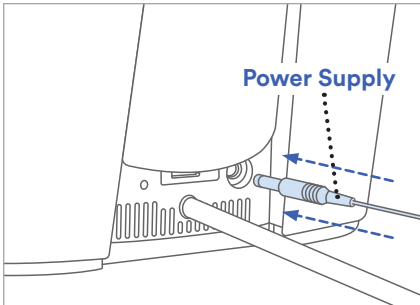

- 3** Plug the **Power Supply** into the back of your SoClean 3 as shown.

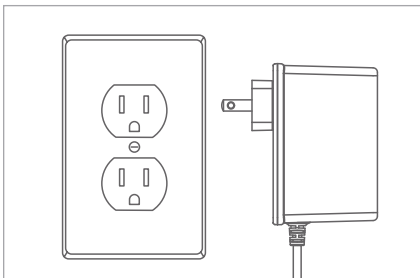

- 4** Plug the **Power Supply** into an AC wall outlet or power strip.

NOTE: Position the SoClean 3 so that it is easy to operate and disconnect from power.

NOTE: Your SoClean 3 does not have a power switch to turn the device on/off. When initially connected to power, the lights on your SoClean 3 will flash a pattern that you may not see if you are not looking at the device immediately after it is connected to power. The SoClean 3 enters a low-power “sleep” mode when not in use and fully powers when you press any of the buttons on the Control Panel.

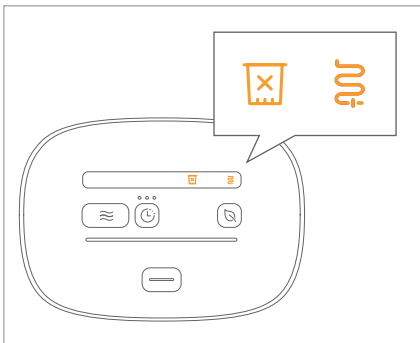

At this point in your SoClean 3 setup, your Control Panel should appear as shown.

NOTE: The Filter Issue and Hose Not Detected icons are illuminated on your Control Panel because the Filter is not yet installed and the sleep equipment mask/hose has not been placed into the SoClean 3 with the Lid closed.

ResMed AirSense 10 Adapter Installation Instructions

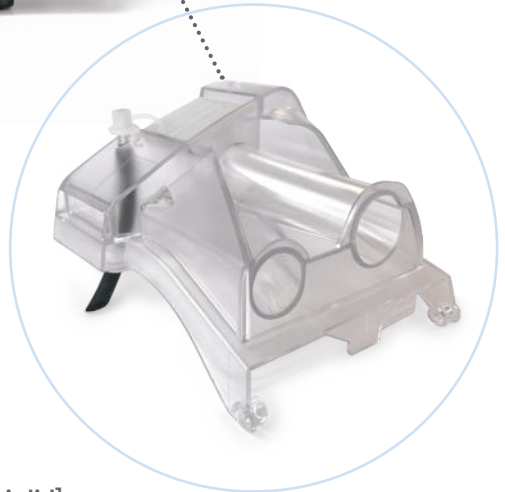

SoClean Adapter
[Replaces the reservoir lid]

SoClean is an independent company not affiliated with ResMed. Names and associated trademarks are solely owned by the respective companies and manufacturers. Depictions of brand logos on our website are for informational and educational purposes only and are used for customer equipment recognition. We are not affiliated or endorsed by any sleep equipment manufacturer.

ADAPTER CONNECTION: SoClean Adapter

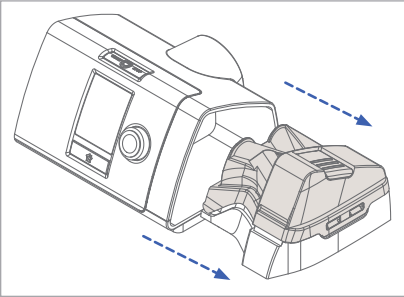

- 1 Remove the reservoir from the sleep equipment machine.

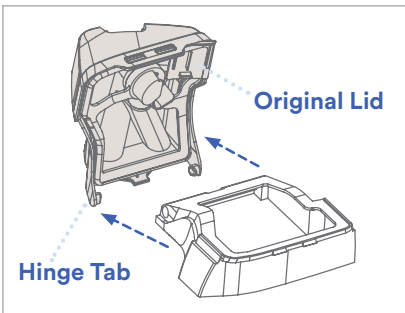

- 2 Remove the **Original Lid** from the sleep equipment reservoir base by opening the **Original Lid** fully, pushing one side of the hinge tab outward, and freeing the **Original Lid** from the base.

Save the **Original Lid** and **Gasket** in case it is needed in the future.

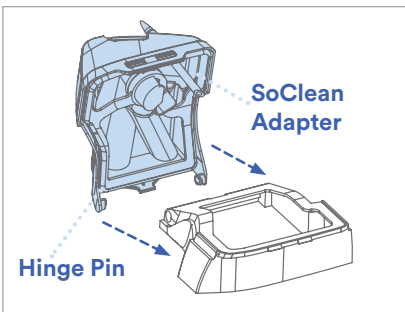

- 3 Install the **SoClean Adapter** to the reservoir base by inserting the hinge pins into the notches on the reservoir base. If needed, insert one hinge pin at a time and gently flex the **SoClean Adapter** to snap it in place.

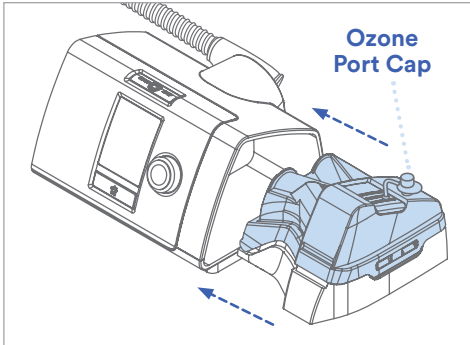

- 4** When using your reservoir, fill with distilled water to the level indicated by the sleep equipment manufacturer. Close the **SoClean Adapter** and insert the reservoir into your sleep equipment unit like you normally would.

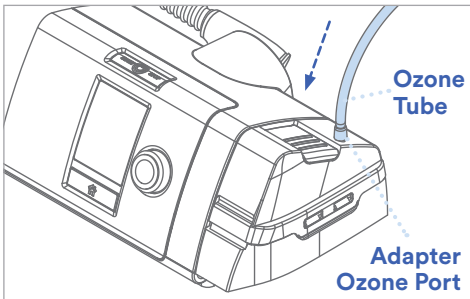

- 5** Uncap the **Adapter Ozone Port**. Connect the **Ozone Tube** to the **SoClean Adapter** by pushing the **Ozone Tube** onto the **Adapter Ozone Port**.

NOTE: The SoClean Adapter can be left connected to your sleep equipment machine after initial setup. You do not need to disconnect the SoClean Adapter to operate either the sleep equipment machine or the SoClean 3.

Adding distilled water to your humidifier reservoir: When you need to add water to your reservoir, remove the reservoir from the sleep equipment machine and remove the **SoClean Adapter**. Add distilled water, reinstall the **SoClean Adapter**, and reinsert into the sleep equipment machine.



WARNING: The **Ozone Tube** should always be connected to the SoClean Adapter and the back of the SoClean 3 unit when operating the SoClean 3.

Installing the Filter



INSTALLING THE FILTER:

The **Filter** converts ozone back to oxygen as it leaves the SoClean 3 **Chamber**. With normal usage of one Maintenance Cycle per day, the **Filter** needs to be replaced approximately every 6 months or when indicated by your device. To order a replacement **Filter**, go to your authorized reseller or SoClean.com. The following steps are used to install the **Filter** in your SoClean 3.

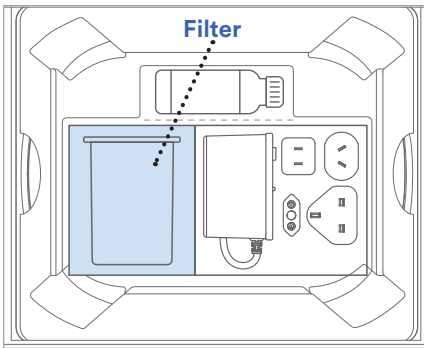

- 1** Locate and remove the **Filter** from the box.

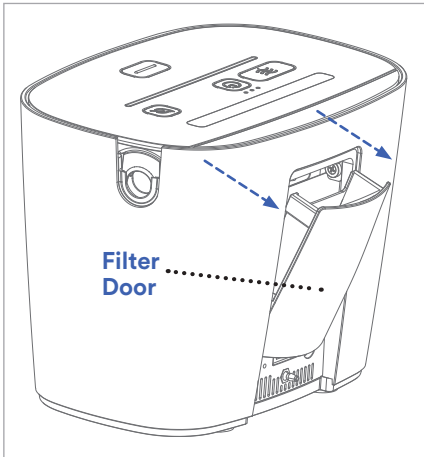

- 2** Locate the **Filter Door** on the back of your SoClean unit and open it by pulling the top edge of the **Filter Door** away from the unit.

NOTE: The Filter Door will open just wide enough for the Filter to slide in.

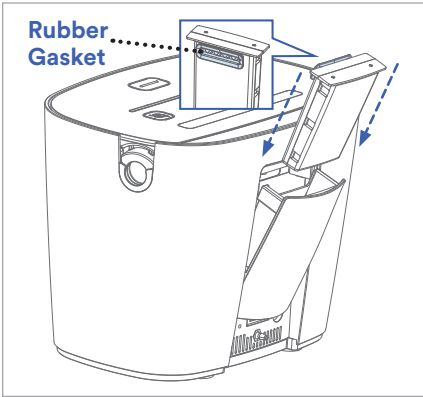

3 Insert the **Filter** into the slot with the blue **Rubber Gasket** facing the **Chamber** as shown.

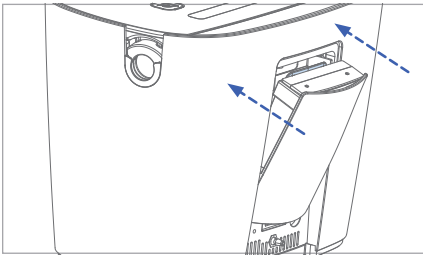

4 Push the **Filter Door** until it is fully closed.

At this point in your SoClean 3 setup, your Control Panel should appear as shown.

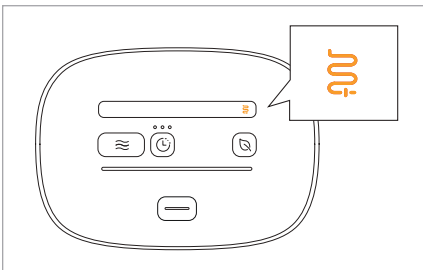

NOTE: The Hose Not Detected icon is illuminated on your Control Panel because a mask/hose has not been placed into the SoClean 3 with the Lid closed.

Congratulations! You have successfully set up your SoClean 3! Proceed to the next page for washing your sleep equipment accessories.

NOTE: If the Filter or Filter Door icon is flashing on your Control Panel, remove and reinstall the Filter, making sure the door is fully closed.

Washing Your Sleep Equipment Accessories



WARNING: Do not put Neutralizing Pre-Wash or water into the SoClean Chamber. Do not use the Neutralizing Pre-Wash on or in the SoClean 3 device. The Pre-Wash is only intended for washing sleep equipment accessories with water in a sink or tub of water.



1

Wash your hose and mask in the sink per manufacturer's recommendations before the first use of your SoClean 3. The Neutralizing Pre-Wash is a washing detergent. If it has not been provided, visit SoClean.com to purchase it. An alternate unscented, mild detergent specified by the sleep equipment manufacturer can also be used.

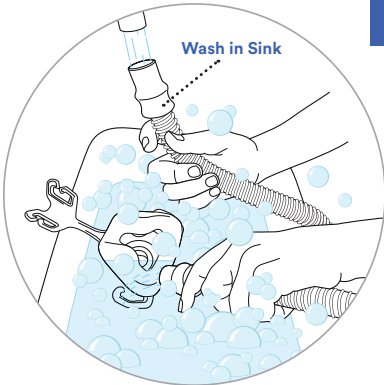

2

Continue to wash your hose and mask in the sink regularly at the interval specified by the sleep equipment manufacturer. Washing removes oils, films, debris and other build up that can naturally form on your equipment from use.

What is Neutralizing Pre-Wash?

- The neutralizing pre-wash can be used to wash your sleep equipment accessories in the sink in order to remove residue like oil from your skin that can naturally build up over time.
- The neutralizing pre-wash is a mild, fragrance-free detergent for washing your sleep equipment. Alternative detergents per your manufacturer's recommendation are also acceptable to use.

How do I use Neutralizing Pre-Wash?

- Use with water in the sink to wash your sleep equipment mask, hose and/or reservoir per the sleep equipment manufacturer's washing instructions.
- Do NOT put the Pre-Wash in or on your SoClean device.

When do I use Neutralizing Pre-Wash?

1. To continue washing your sleep equipment accessories according to the manufacturer's recommended interval and method.

For example, the manufacturer may recommend a weekly washing of the hose and mask in the sink. You should keep washing your sleep equipment in this way even after you start using a SoClean 3.

2. To wash any new mask, hose, or reservoir before using them with your SoClean device for the first time.

Using Your SoClean 3

Once you have completed the setup steps, you are ready to begin the daily maintenance of your sleep equipment accessories with your SoClean 3.

SoClean 3 connected to ResMed Airsense 10



Safety Checklist Before Using Your SoClean 3

- Sleep equipment accessories are washed in sink before first use and at manufacturer's recommended interval (page 20)
- SoClean Adapter is installed on sleep equipment machine (page 14)
- Ozone tube is connected to sleep equipment machine (page 16)
- Sleep equipment hose is still connected to sleep equipment machine and mask
- SC3 is powered on (page 12)
- Filter is installed (page 17)

MAINTENANCE CYCLE

The SoClean 3 can be used daily to maintain your sleep equipment accessories in approximately 1 hour and 15 minutes with the Maintenance Cycle.

IMPORTANT: The SoClean 3 device will not operate without the mask and hose present in the securely closed Chamber. Additionally, the SoClean 3 will not operate if the sleep equipment hose or Filter is not present with the Filter Door closed.

CAUTION: In the event of loss of power to your home or the SoClean 3 device, you will need to rerun the entire Maintenance Cycle to make sure your sleep equipment accessories have been properly maintained.

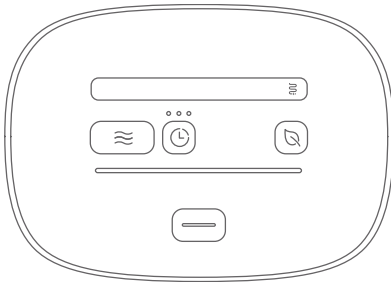

1 Ensure your SoClean 3 is ready for use by completing the steps on the safety checklist (page 22).



STOP: ensure you are following the steps to properly wash your sleep equipment accessories before first use of SoClean 3 and as part of your ongoing cleaning routine (page 20).

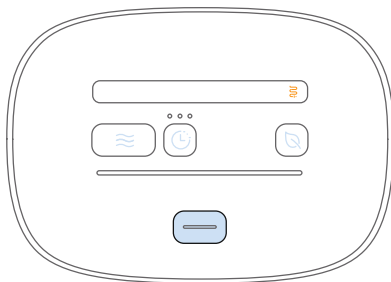

2 Press the **Lid Open** button to open the Lid.

NOTE: The Lid will spring open and **blue** light will illuminate from the inside of the bottom of the Chamber. The buttons on the Control Panel will illuminate **blue** and the **Hose Not Detected** icon will illuminate **amber** since there is no mask or hose installed in the device.

USING YOUR SOCLEAN 3

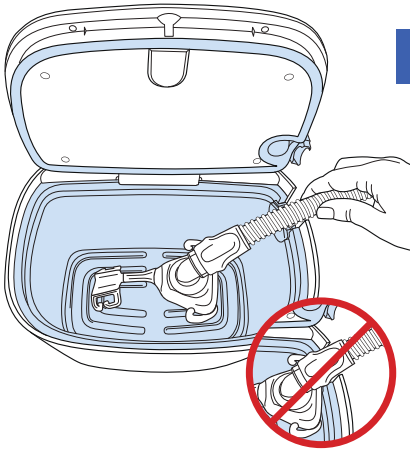

3 Place your mask into the Chamber and route the hose through the Hose Slot.

CAUTION: Rest the flexible part of the hose, not the rigid mask connector, in the Hose Slot to ensure a proper seal.

CAUTION: Ensure all tubing and hoses are free of kinks prior to operating the SoClean 3.

IMPORTANT: Make sure the sleep equipment hose is still connected to the sleep equipment device and the Ozone Tube is properly connected to the Hose Port on the Adapter and to the back of the SoClean 3 (page 16).

NOTE: Some head gear contains nylon which is not compatible with ozone. It is recommended to remove head gear before placing the mask into the Chamber.

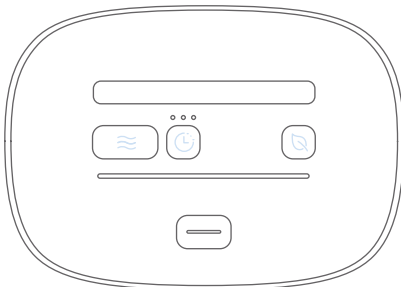

4 Push the Lid down until it latches shut.

NOTE: With your mask and hose properly installed and the Lid closed, the system defaults to a 2-hour cycle start Delay, or the last Cycle Delay programmed. The buttons will illuminate **blue** for a few seconds and the Cycle Delay button will show the programmed delay.

- No delay
- 2-hr delay selected (default)
- 4-hr delay selected
- 8-hr delay selected

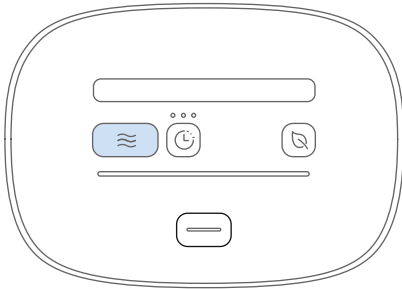

5 To run the Maintenance Cycle immediately, press the **Maintenance Cycle** button to start. This overrides the Cycle Delay.

NOTE: You should hear the ozone generator and air pump turning on and off periodically over the 1 hour and 15 minute Maintenance Cycle.

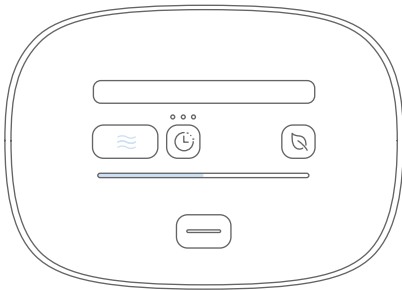

NOTE: The **Maintenance Cycle** button will illuminate **blue** to indicate the Maintenance Cycle is operating. The **Progress Bar** on the Control Panel will illuminate **blue** from left to right as the cycle proceeds to completion.

NOTE: It is important to leave your mask and hose in the SoClean 3 for the complete Cycle duration to ensure full maintenance of your sleep equipment accessories.

NOTE: If you need to remove your sleep equipment accessories before the Maintenance Cycle is complete, see the “Canceling a Cycle” section.

The SoClean will operate the air pump and circulating fan for the last 12 minutes of the Cycle duration to move fresh air through the system.

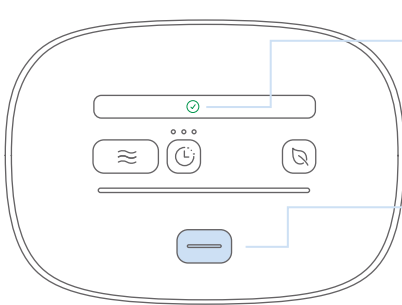

6 At the end of the Maintenance Cycle, the **Cycle Complete** icon will light up **green**. You can now press the Lid Open Button and remove your mask.

Your sleep equipment is now ready for use!

Your sleep equipment accessories are ready for use!

FRESH AIR CYCLE [OPTIONAL]

The Fresh Air Cycle can be used daily to freshen the air in your mask and hose before use. Typically, your mask and hose will still be in your SoClean 3 from a Maintenance Cycle and the Fresh Air Cycle can be started with a simple one-button push.

NOTE: The Fresh Air Cycle does not maintain your sleep equipment accessories.

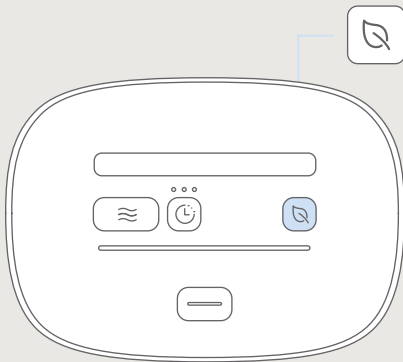

1

With your mask and hose sitting in your SoClean 3, simply press the **Fresh Air Cycle** button to initiate the process. This will override the programmed Cycle Delay if it is active.

NOTE: If your sleep equipment accessories are not already in your SoClean 3, insert your mask and hose as you would to operate a Maintenance Cycle.



The Fresh Air Cycle will take approximately 5 minutes to complete. During the Fresh Air Cycle, the **Fresh Air Cycle** button will illuminate **blue** to indicate the Fresh Air Cycle is operating. The **Progress Bar** on the Control Panel will progressively illuminate **blue** as the cycle proceeds to completion.

NOTE: Running a Fresh Air Cycle does not reduce the life of the Filter.

WARNING: Do not forcibly open the SoClean 3 Lid before the Cycle completes.

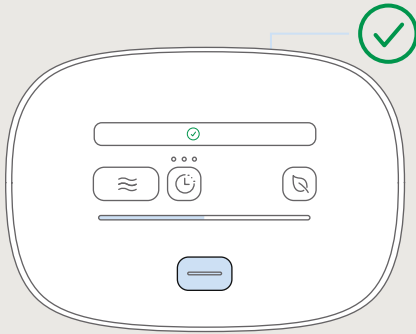

2

At the end of the Fresh Air Cycle, the **Cycle Complete** icon will light up **green**. You can now open the Lid and remove your mask and hose.

NOTE: You can run only 3 consecutive Fresh Air Cycles before you must run a Maintenance Cycle. This ensures that your sleep equipment accessories are properly maintained.

DELAY YOUR MAINTENANCE CYCLE

In the event that you would like the SoClean 3 to operate at a more convenient time, you can delay your Maintenance Cycle by 2, 4, or 8 hours. For your convenience, the system automatically defaults to a 2-hour delay or the last delay that you've selected so you can just place your mask into the Chamber, close the Lid, and walk away. Your SoClean 3 will automatically run after this Cycle Delay elapses.

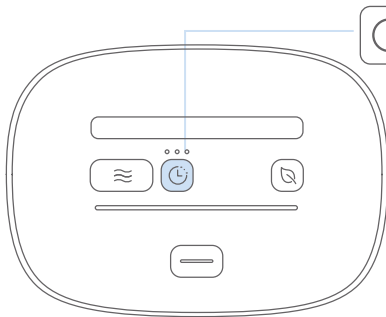

1 With your mask in your SoClean 3, press the **Cycle Delay** button to select the cycle delay time. The delay button will flash to indicate that the Cycle Delay can be changed.

NOTE: Your mask and hose must be in your SoClean 3 with the Lid closed to select a Cycle Delay.

The Cycle Delay time is selected by one or more button presses, as indicated by the **blue** icons above the **Cycle Delay** button.

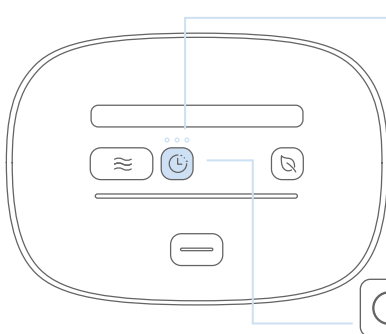

	○ ○ ○	
PRESS	INDICATION	DELAY
1 time	1 blue indicator	2-hour
2 times	2 blue indicators	4-hour
3 times	3 blue indicators	8-hour
4 times	No blue indicator	OFF

NOTE: Allow approximately 1 second between button presses when selecting the Cycle Delay.

NOTE: After approximately 3 seconds, the Cycle Delay button will stop flashing indicating that the countdown has started. You can cancel the Cycle Delay by pressing the Cycle Delay button once more. You will know the Cycle Delay is canceled because there will be no blue indicator lights visible.

During the selected delay time, the **Cycle Delay** button and indicator(s) above the button will illuminate **blue** until the Maintenance Cycle starts.

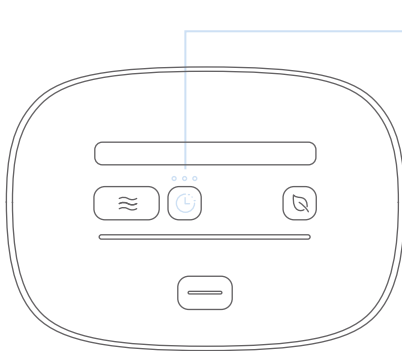

NOTE: You can override the Cycle Delay after it's set. To do so, press the Maintenance Cycle button to immediately start maintaining or the Fresh Air Cycle button to freshen the air in your sleep equipment.

To cancel the Cycle Delay function: Press the Cycle Delay button until no Delay indicator lights are showing.

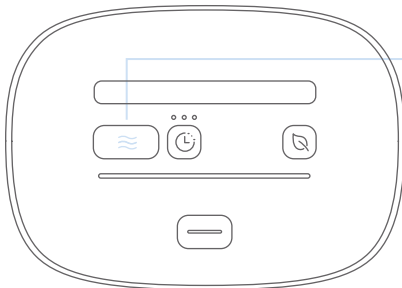

2

Once the selected Cycle Delay time has elapsed (e.g. 2 hour), the Maintenance Cycle will automatically begin.

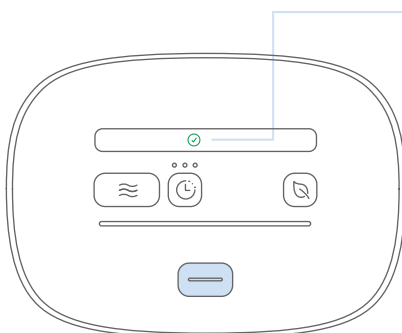

3

At the end of the Cycle Delay and Maintenance Cycle, the **Cycle Complete** icon will light up **green**. You can now open the Lid and remove your mask and hose.

The Cycle Delay and Maintenance Cycle were successfully run and your sleep equipment is ready for use!

NOTE: You cannot set a delay for a Fresh Air Cycle, only for the Maintenance Cycle.

CANCELING A CYCLE

If you need to remove your sleep equipment accessories while an active Maintenance Cycle is taking place, you can cancel the cycle.

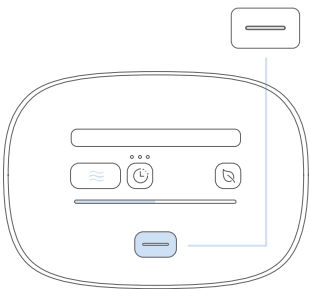

1 Press and hold the **Lid Open** button for approximately 5 Seconds.

NOTE: You can cancel the Maintenance Cycle at any time regardless of where your SoClean 3 is in the process of maintenance.

The SoClean 3 will pump air through the system for approximately 12 minutes after the Maintenance Cycle is canceled in order to clear ozone from your sleep equipment.

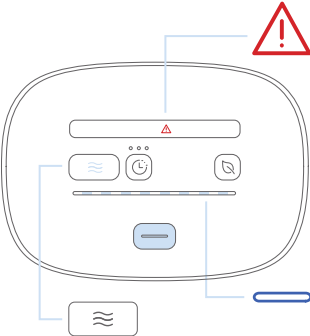

While the Maintenance Cycle cancellation is in progress, the following will illuminate:

- **Fault/Unable to Run** icon will illuminate **red**
- **Cycle Start** button will illuminate **blue**
- **Progress Bar** on the **Control Panel** will flash **blue**

The **Lid** will remain locked until the cancellation is complete.

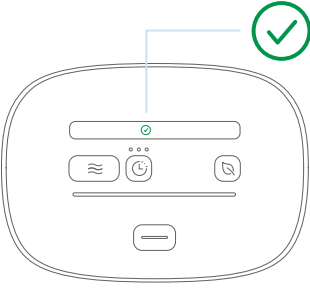

2 At the end of the Maintenance Cycle cancellation, the **Cycle Complete** icon will light up **green**. The Maintenance Cycle was successfully canceled. You can now press the Lid Open button and remove your mask.

Your sleep equipment accessories may not have been fully maintained, but are available for use!

WARNING: Do not forcibly open the SoClean 3 Lid before the Cycle completes.

TRAVELING WITH YOUR SLEEP EQUIPMENT:

It is not necessary to replace your SoClean Adapter with the original lid.

IMPORTANT: Once the adapter is installed, it is your new permanent lid. If you need to disconnect the SoClean from your adapter for travel, simply disconnect the ozone tube from the adapter and re-cap the ozone port. If you fail to do this, the water in your humidifier will be pushed out through the Adapter Ozone Port and an overflow will result.

In the rare instance that you may wish to reconnect your original reservoir lid, please follow these instructions.

RECONNECTING THE ORIGINAL LID:

SoClean Adapter

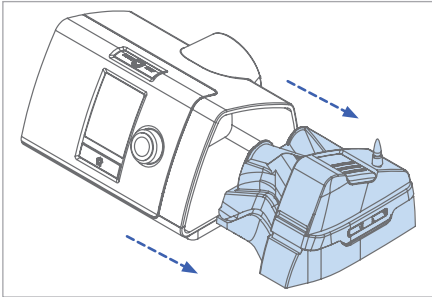

- 1 Remove the reservoir from the sleep equipment machine.

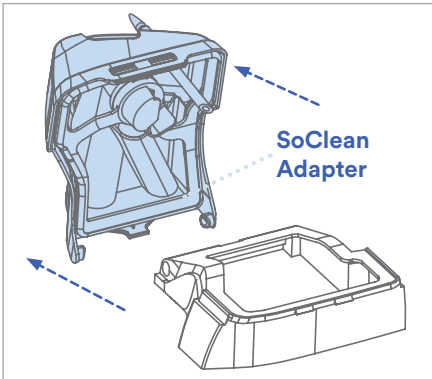

- 2 Remove the **SoClean Adapter** from the reservoir base by opening the **SoClean Adapter** fully, pushing one side of the hinge tab outward, and freeing the **SoClean Adapter** from the base.

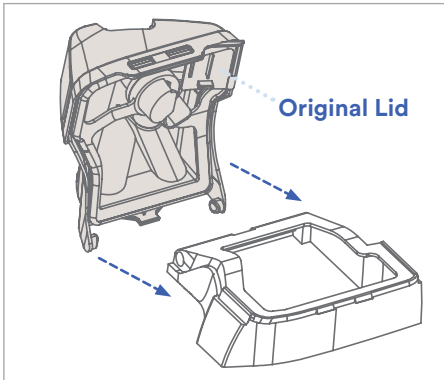

3 Install the **Original Lid** and **Gasket** to the reservoir base by inserting the hinge pins into the notches on the reservoir base. If needed, insert one hinge pin at a time and gently flex the lid to snap it in place.

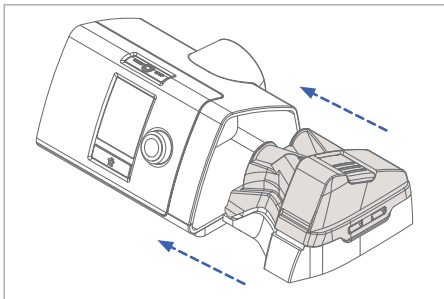

4 Close the **Original Lid** and install the reservoir back into your sleep equipment device.

NOTE: SoClean is not responsible for damage to your sleep equipment machine or personal property resulting from equipment mishandling.

Your SoClean 3: Parts & Icons

See page 11 for setup instructions

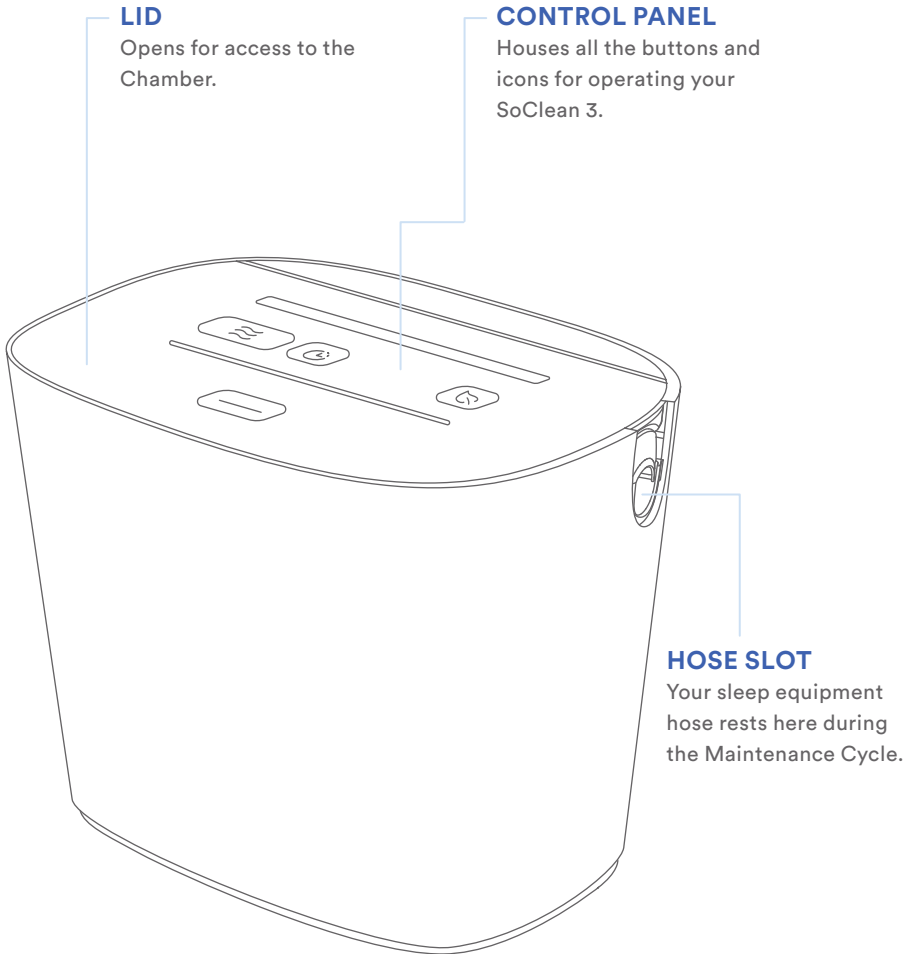

NOTE:
SoClean 3 Lid can only be opened when the device is plugged in.

LID LATCH

Keeps the Lid of the SoClean 3 closed securely during the Maintenance Cycle and Fresh Air Cycle.

LID GASKET

Seals the Lid in order to contain ozone within the Chamber.

HOSE DETECT SENSOR

Your SoClean 3 operates only with proper configuration. A Maintenance Cycle or a Fresh Air Cycle will not begin unless a sleep equipment hose is detected and the Lid is closed.

MAINTENANCE CHAMBER

Place your mask, while still connected to the hose, inside for maintenance when running a Maintenance Cycle. The inside of the Chamber is illuminated for visibility in low-light settings.

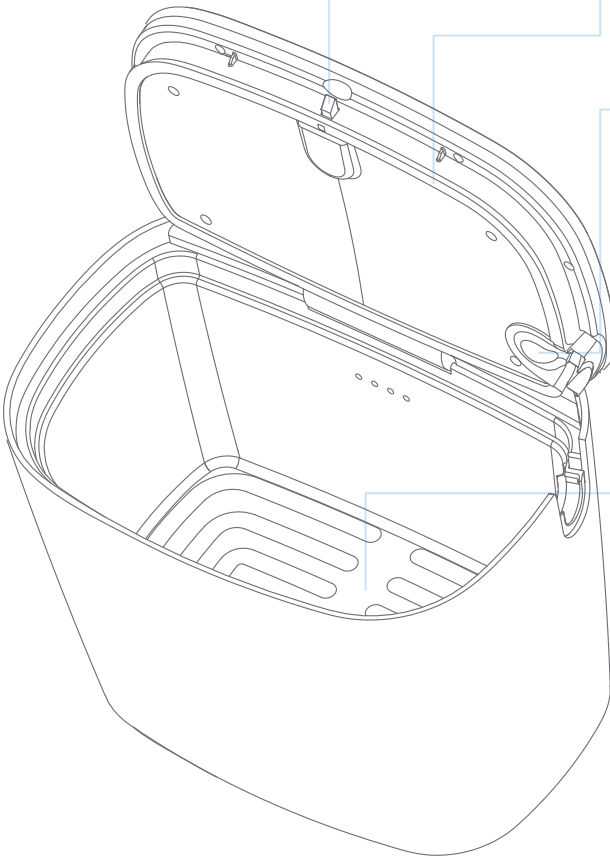

FILTER

The Filter converts ozone in your SoClean 3 and sleep equipment accessories into fresh oxygen as it exhausts from the unit. This component must be replaced every 6 months. Your SoClean 3 reminds you when it needs replacement.

FILTER DOOR

Your Filter goes in here. The SoClean 3 unit will not operate a Maintenance Cycle or Fresh Air Cycle if the Filter Door is open.

PHONE CHARGING PORT

A USB port is provided on the back of your SoClean 3 to conveniently charge your cell phone when your SoClean 3 is connected to power.

POWER INPUT

The cable from the Power Supply provided with your SoClean 3 plugs in here.

OZONE TUBE

One end of the Ozone Tube connects to your SoClean Adapter, and the other end comes already attached to the back of the SoClean 3. This tube is what circulates ozone or air through your sleep equipment accessories during the Maintenance Cycle and Fresh Air Cycle.

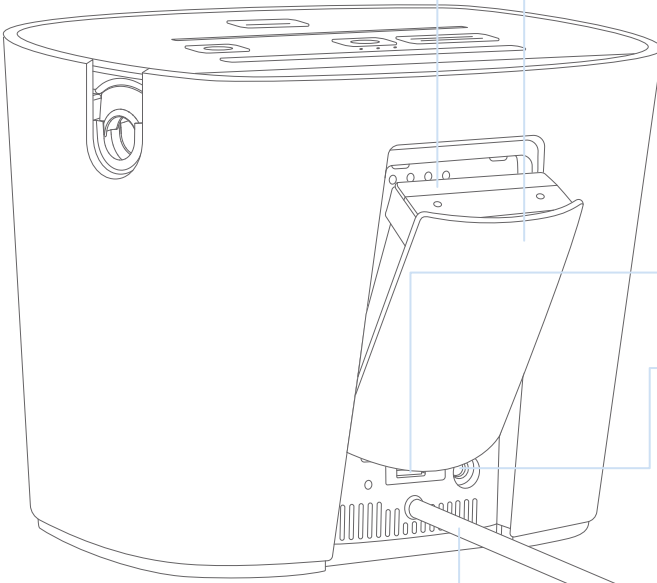

CONTROL PANEL

Get to know the **buttons** used to control the device operation and the **icons** that will tell you what is happening.

Buttons

There are 4 buttons on the Control Panel that are used to operate your SoClean 3. Buttons illuminate **blue** when any one button is pressed to help with visibility in low-light conditions.

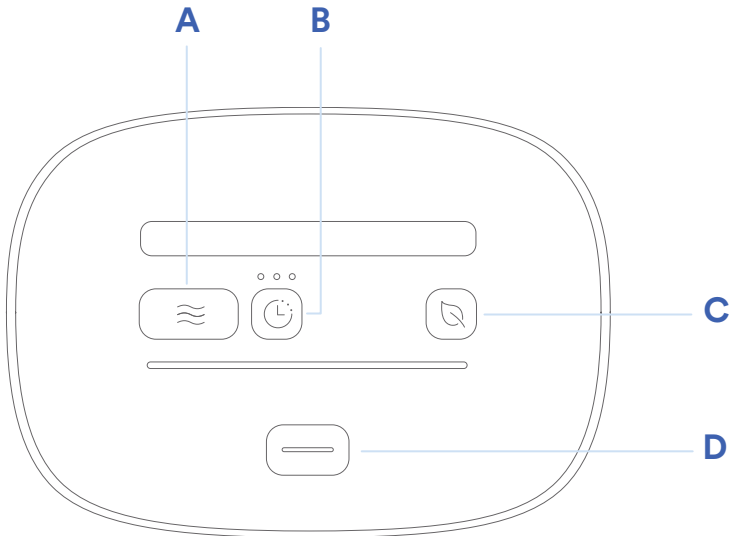

NOTE: There is no power button on your SoClean 3. The device is connected to power and “on” when the Power Supply is plugged into your SoClean 3 and the AC wall socket.

Buttons (CONT.)

A



**MAINTENANCE
CYCLE**

Starts the maintenance process with a single push.

NOTE: Your mask and hose must be present in the SoClean 3 with the Lid closed to operate the Maintenance Cycle.

B



**CYCLE
DELAY**

Used to set a 2, 4, or 8 hour delay to the start of your Maintenance Cycle.

Set delay by pressing once for 2 hours, twice for 4 hours, three times for 8 hours, and four times to turn the Delay feature off.

NOTE: For your convenience, the system automatically defaults to the Cycle Delay that was last run. If the Cycle Delay was not used, the system will default to a 2-hour delay.

NOTE: The Cycle Delay will automatically occur without needing to press the Maintenance Cycle button.

C



**FRESH AIR
CYCLE**

Runs air through the system to freshen your equipment with the push of a button.

NOTE: The Fresh Air Cycle does not maintain your sleep equipment accessories.

NOTE: Your mask and hose must be present in the SoClean 3 with the Lid closed to operate the Fresh Air Cycle.

D

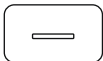

LID OPEN

Opens the Lid when the device is connected to power. This button can also be used to cancel an active Maintenance Cycle by pressing and holding for 5 seconds.

NOTE: If canceling a Cycle, Lid cannot be opened until Cycle Complete Icon illuminates. (See page 30.)

Icons

There are 7 illuminated icons on the Control Panel that the SoClean 3 uses to communicate with you. Normally, the icons are off if the device is idle and operating normally. See the notes below about why these icons may illuminate and when you can expect to see them.

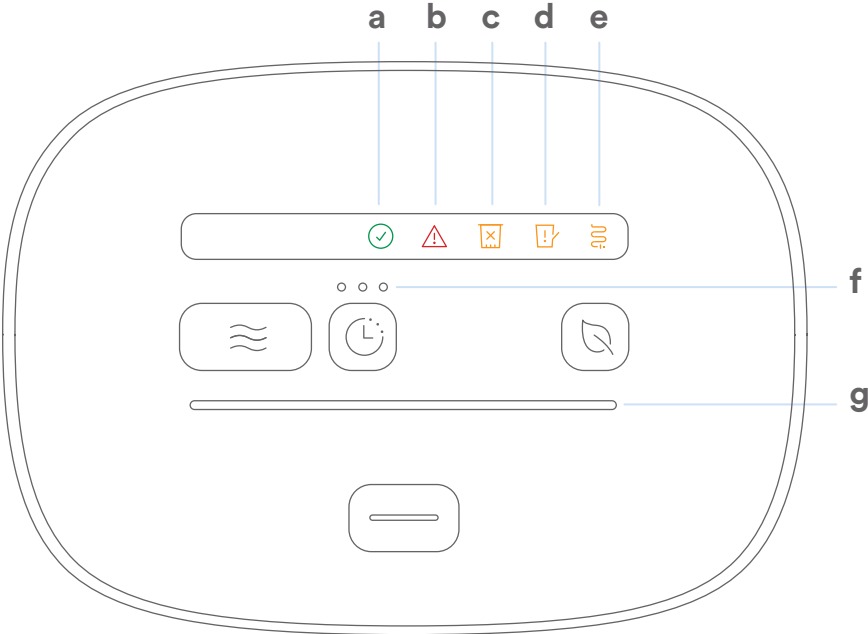

a  **CYCLE COMPLETE**

Solid Green

Indicates that either a Maintenance Cycle or Fresh Air Cycle is complete and that the Lid can be opened.

NOTE: This icon will be illuminated continuously after the cycle completes until you open the Lid to remove your sleep equipment accessories. After you open the Lid, the light will turn off.

Icons (CONT.)

b  **FAULT/
UNABLE
TO RUN**

Solid Red

Indicates when your SoClean 3 has detected an issue that prevents operating a Maintenance Cycle or Fresh Air Cycle.

NOTE: When this icon is illuminated, the device may be operating the cancellation process (page 30) to remove ozone from the system prior to allowing the Lid to be opened.

c  **FILTER
ISSUE**

Flashing Amber

Indicates that it is time to order a new Filter. This icon will **flash amber** only when you interact with your SoClean. From the time it begins to flash amber, you have 30 days or 30 uses (whichever comes first) to replace the Filter. You can still use your SoClean 3 to maintain your sleep equipment accessories during this time.

Solid Amber

1. May indicate that your Filter has expired and will need to be replaced. **You will not be able to operate a Maintenance Cycle or a Fresh Air Cycle.**
2. Missing or counterfeit Filter. If you have installed a new Filter in your SoClean 3 and this icon illuminates **solid amber** when the Filter door is closed, you may have purchased a counterfeit SoClean 3 Filter and your SoClean will not operate. Please purchase filters from SoClean.com to ensure authenticity. If filter error persists, and the filter was purchased from SoClean.com, call customer care for further assistance.

Icons (CONT.)

c  FILTER ISSUE

Solid Amber (Cont.)

NOTE: You cannot operate a Maintenance Cycle or Fresh Air Cycle unless your SoClean 3 recognizes that a genuine SoClean 3 Filter is installed and the Filter Door is closed.

If you are unable to clear this icon by installing a new Filter and closing the Filter Door, please contact SoClean customer support.

d  FILTER DOOR ISSUE

Solid Amber

Indicates that the Filter Door is not completely closed. Check your Filter Door and open/close it securely.

e  HOSE NOT DETECTED

Solid Amber

Indicates that your sleep equipment hose is not present or detected when the Lid is closed.

NOTE: Your SoClean 3 will not operate a Maintenance Cycle or Fresh Air Cycle if your mask and hose are not installed or detected in the unit with the Lid closed.

Flashing Amber

Error detecting the hose. Open and close Lid with mask and hose installed to continue.

Icons (CONT.)

f  2, 4, 8 HOUR
CYCLE DELAY

Flashing Blue

Indicates that the Cycle Delay can be changed by pressing the Cycle Delay button.

NOTE: Mask and hose must be installed with the Lid closed to modify and activate the Cycle Delay.

Solid Blue

Indicates if a Cycle Delay has been programmed. Three indicator lights are provided.

One light illuminated	= 2 hr delay selected (default)
Two lights illuminated	= 4 hr delay selected
Three lights illuminated	= 8 hr delay selected
No lights illuminated	= no cycle start delay selected

The delayed cycle will automatically run at the set time. You do not need to press any additional buttons to confirm the delayed start time.

g  CYCLE
PROGRESS
BAR

Progressive Blue

Gradually turns **blue** from left to right as an indication of progress for a Maintenance Cycle or Fresh Air Cycle.

NOTE: When the entire bar is illuminated **blue** the cycle is nearly complete.

**Flashing Blue**

A Cycle cancellation is in progress.

**Solid Red**

Indicates that an active Maintenance Cycle has been interrupted (example: temporary loss of power).

NOTE: During this time, your SoClean 3 is pumping air through the system to remove ozone.

Maintenance

CLEANING YOUR SOCLEAN 3

To clean, wipe the interior and exterior of your SoClean 3 device with a slightly damp cloth or sleep equipment wipes. Please note that the Neutralizing Pre-Wash should be used only on your sleep equipment accessories and should not be used on or in the SoClean 3 device. Do not submerge the SoClean 3 device in liquid or use chemical cleaners. Do not put water inside the SoClean 3 device.

PRE-WASH YOUR SLEEP EQUIPMENT ACCESSORIES

Use the Pre-Wash or unscented mild detergent to wash your sleep equipment accessories according to the sleep equipment manufacturer's recommended method and interval. In addition, do this prior to using the SoClean 3 for the first time or when introducing new sleep equipment accessories.

CAUTION: Use the Pre-Wash or unscented mild detergent to wash your sleep equipment accessories according to the sleep equipment manufacturer's recommended method and interval. Use the SoClean 3 for daily supplemental maintenance of your sleep equipment accessories.

VISIBLE CRACKS OR DAMAGE

WARNING: If the SoClean system is dropped, it may become damaged. Especially after the system has been dropped, regularly inspect the SoClean 3 for physical damage, such as cracks or broken structure, damaged gaskets, and cracks in the Ozone Tube or sleep equipment hose. Discontinue use if damage is detected and contact SoClean for assistance.

REPLACING THE FILTER

The Filter must be replaced approximately every 6 months depending on usage. The Filter Issue icon will flash **amber** to remind you to change your Filter. **The device will no longer operate a Maintenance Cycle if the Filter replacement warning expires and turns solid amber before the Filter is replaced.**

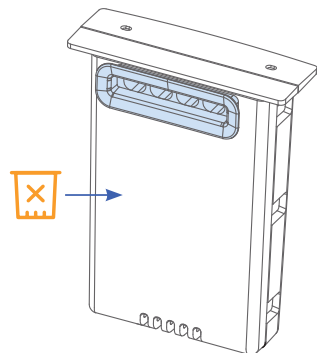

REORDERING PARTS OR ACCESSORIES

To reorder supplies (Filter or Neutralizing Pre-Wash), contact your authorized reseller or visit SoClean.com.

For safety and extended product life, use only authentic SoClean 3 parts. Please purchase your Filters from SoClean.com to ensure authenticity. For purchases from an online marketplace, such as Amazon® or eBay®, please check “sold by” SoClean before making your purchase. Authentic SoClean Filters contain unique technology required for safe use of the SoClean device. The manufacturer is not responsible for device malfunction or accidents caused by the use of inauthentic parts or accessories. Please contact SoClean immediately if you have any issues with your Filter.

Your SoClean 3 device has been designed to work only with authentic SoClean 3 Filters. You will not be able to operate your SoClean system with an inauthentic SoClean 3 Filter.

Amazon® is a registered trademark owned by Amazon Technologies, Inc. eBay® is a registered trademark owned by eBay, Inc. SoClean® is a registered trademark owned by SoClean, Inc.

Part Name	SKU	Description
Ozone Tube	PN1404	This tube is what circulates ozone or air through your sleep equipment accessories during the Maintenance Cycle and Fresh Air Cycle.
Filter	PN1407	The Filter converts ozone in your SoClean 3 and sleep equipment accessories into fresh oxygen as it exhausts from the unit. This component must be replaced every 6 months and your SoClean 3 reminds you when it needs replacement.
8 FL.OZ. Neutralizing Pre-Wash	PN1101.8	The Neutralizing Pre-Wash removes any material or odor that could react with ozone. Wash your sleep equipment accessories before connecting the SoClean device or when you receive a new mask, hose, or reservoir.
Power Supply	PN1422-IP22	Used to power your SoClean 3.

General Troubleshooting

PROBLEM

YOU SEE

POSSIBLE CAUSES

The warning sign appears and all three buttons flash three times



Your device is locked.

SoClean 3 will not operate a Maintenance Cycle or Fresh Air Cycle



This icon is solid **amber** on the Control Panel

There may be an issue with the sleep equipment hose detection.

The Lid may not be closed.

Your sleep equipment hose may be incompatible.



This icon is flashing **amber** on the Control Panel

The hose may have been detected after the Lid was closed.

User attempted to defeat the hose Detect feature.



This icon is solid **amber** on the Control Panel

The Filter door may be open.



This icon is flashing **amber** on the Control Panel

Time to order a new Filter.



This icon is solid **amber** on the Control Panel

The Filter is expired or counterfeit Filter is installed.



This icon is solid **red** on the Control Panel

There may be an internal device issue.

SOLUTIONS

Contact Customer Care to unlock your device.

Check that your sleep equipment hose has been properly placed into the Hose Slot and the Lid is fully closed.

Check to see if the Lid is fully closed.

Some sleep equipment hoses may not be compatible with your SoClean 3. Contact SoClean Customer Care.

Open/close Lid with mask and hose installed to continue.

Do not attempt to defeat the Hose Detect feature.

Open and securely close the Filter door.

Order a replacement Filter.

Replace with a new genuine Filter.

Unplug your SoClean 3 from its power source and plug it back in. If the issue persists, contact SoClean Customer Care.

PROBLEM

YOU SEE

None of the lights illuminate, even when you press buttons

SoClean 3 will not operate a Fresh Air Cycle



Fresh Air Button flashes when pressed.

Lid does not open when the Lid Open button is pressed



These icons are illuminated **blue** on the Control Panel.



No buttons light up.



You hear a click and the buttons light up **blue** but the Lid doesn't open.

The SoClean 3 is making a noise like it's operating but there are several red indicators on the control panel



These icons are illuminated on the Control Panel.

POSSIBLE CAUSES	SOLUTIONS
The SoClean 3 may not be connected to power.	Check that the Power Supply is plugged in correctly into the back of the SoClean 3 and the AC wall outlet. If the issue persists, contact SoClean Customer Care.
You have run 3 consecutive Fresh Air Cycles.	Run a Maintenance Cycle.
The Maintenance Cycle is running.	The Lid is locked during a Maintenance Cycle. To cancel the cycle, press the Lid Open button for approximately 5 seconds. It will take approximately 12 minutes before you can access your sleep equipment accessories.
Your SoClean 3 may not be connected to power.	Check that the Power Supply is plugged into the wall and the back of the device.
The Lid may be stuck.	After you press the Lid Open button and hear the click, pull up gently on your sleep equipment hose to assist in opening the Lid.
<p>Your SoClean 3 was operating a Maintenance Cycle and one of the following occurred:</p> <ul style="list-style-type: none"> • Power to the SoClean 3 was momentarily lost • Lid was forced opened • The sleep equipment hose was not detected after the Maintenance Cycle started • Internal Device Issue 	<p>Your SoClean 3 is pumping air through the system to remove ozone and allow you to access your accessories. Allow this cycle to complete. You can either remove your accessories for use or start a new Maintenance Cycle when the green Cycle Complete icon appears.</p> <p>NOTE: Your sleep equipment accessories may not have been fully maintained before this issue occurred.</p>

PROBLEM	YOU SEE	POSSIBLE CAUSES
<p>Cycle Delay did not start or was turned off</p>	 <p>None of the delay indicators are illuminated blue.</p>	<p>Delay button may have been pressed a fourth time while setting the delay or accidentally pressed after the Cycle Delay countdown started.</p>
<p>Strong scent of ozone during Maintenance Cycle (sweet chlorine-like smell)</p>	<p>SoClean 3 appears to operate normally.</p>	<p>There may be physical damage to your SoClean 3.</p> <hr/> <p>The ozone tube may be disconnected.</p>
<p>There is a strong scent in your sleep equipment after using my SoClean 3</p>	<p>SoClean 3 appears to operate normally.</p>	<p>There may be contaminants or fragrance in your sleep equipment accessories.</p>
<p>Your mask is discoloring</p>	<p>SoClean 3 appears to operate normally.</p>	<p>Handwashing per the sleep equipment manufacturer's recommendations may not be occurring.</p> <hr/> <p>Ozone may be reacting with water that is on your mask.</p> <hr/> <p>Material in your mask may be incompatible with ozone. Contact us for more information.</p>
<p>You're developing a rash where the mask touches your face</p>		<p>Handwashing per the sleep equipment manufacturer's recommendations may not be occurring.</p> <hr/> <p>Material in your mask may be incompatible with ozone. Contact us for more information.</p>

SOLUTIONS

Be sure to leave one second between presses and do not press again after the initial setting unless you intend to cancel the Cycle Delay.

Disconnect the SoClean from power and leave the room for several minutes. Inspect your SoClean 3 for damage, such as cracks in the plastic components, cracks in the Ozone Tube, and broken/torn/missing gaskets in the device Lid. Check the Ozone Tube and ensure it is properly connected to the back of your SoClean 3 and your SoClean Adapter. Discontinue use of your SoClean device if it is physically damaged. If you smell ozone and believe the SoClean device is not operating correctly, disconnect the power to the device and contact SoClean.

Wash your mask and hose with the Neutralizing Pre-Wash or unscented, mild detergent. Do not use scented detergent or vinegar as they can react with the ozone and produce undesirable odors. You can also operate a Fresh Air Cycle before use to freshen the air in your sleep equipment.

Discontinue use and contact SoClean Customer Care.

Be sure your mask is completely dry before operating a Maintenance Cycle.

Regularly wash your sleep equipment accessories per the manufacturer's recommendation.

CAUTION: Discontinue use of your SoClean 3, consult your health care professional and contact SoClean customer care if acne or a rash develops along the mask contact line.

Regularly wash your sleep equipment accessories per the manufacturer's recommendation.

Warranty Information

SoClean Inc. warrants this product, SoClean 3, non-inclusive of replacement parts, under a two (2) year limited warranty for defects in manufacture or workmanship.

For all warranty issues, a return authorization number and proof of purchase is required. Please contact SoClean at SoClean.com. Returned products must be shipped prepaid and insured. CODs are not accepted. Products repaired or replaced under warranty will not incur reshipping charges. Under this warranty, the sole remedy shall be repair or replacement at SoClean's discretion.

IMPORTANT: To ensure authenticity, filters must be purchased directly from SoClean or from an authorized reseller store or website. For purchases from an online marketplace such as Amazon®, please check "sold by" SoClean before making your purchase. **Your SoClean 3 device has been designed to work only with genuine SoClean 3 Filters. You will not be able to operate your SoClean System with an inauthentic SoClean 3 Filter.** Warranties will be voided if the product is used with an inauthentic Filter and not replaced in accordance with usage instructions.

LIMITATION DAMAGES: SOCLEAN SHALL NOT BE LIABLE FOR ANY INCIDENTAL OR CONSEQUENTIAL DAMAGES FOR BREACH OF ANY EXPRESS OR IMPLIED WARRANTY ON THIS PRODUCT.

NO LIABILITY ARISING FROM ITS USE, HOWEVER, CAN BE ACCEPTED BY THE COMPANY, WHO RESERVES THE RIGHT, WITHOUT PRIOR NOTICE, TO ALTER THE SPECIFICATIONS, CONSTRUCTION, OR CONTENT OF ITS EQUIPMENT AT THE COMPANY'S OWN DISCRETION.

For further questions or concerns, visit our website: SoClean.com | Call: 866-501-3705

WARRANTY REGISTRATION



Two ways to register

1. Online at SoClean.com/warranty
2. Complete the form below.

Mail this form to: SoClean Inc., ATTN: Warranty Registration, 12 Vose Farm Road, Peterborough, NH 03458

Name _____

Address _____

City/State/Zip _____ Phone _____

Email _____ Date Purchased _____

Serial Number S C 1 4 0 0

Look for the **SN** symbol on the bottom of the unit and enter the number beginning with SC1400 as shown in the sample image:



Purchased From: Direct from SoClean In a store Amazon Received as a gift Other _____

Which sleep equipment model do you use with your SoClean? _____

Yes! I would like to receive future discounts and tips for a healthier lifestyle.

PLEASE PROVIDE PROOF OF PURCHASE IF YOU DID NOT BUY YOUR SOCLEAN FROM US.



Thank you for purchasing the SoClean 3.

Please read this entire manual carefully before using your SoClean 3 and keep it for future reference.

Questions? Contact us at **[SoClean.com/contact](https://www.soclean.com/contact)**

For warranty information, visit **[SoClean.com/warranty](https://www.soclean.com/warranty)**

For further questions or concerns or for more information about SoClean 3 or our other innovative products, please visit **[SoClean.com](https://www.soclean.com)**

866-501-3705

Copyright © 2011-2021

SoClean® is a registered trademark of SoClean, Inc.
12 Vose Farm Road, Peterborough, NH 03458, U.S.A.

Patent: [SoClean.com/patents](https://www.soclean.com/patents)

Issue Date: 07/2021