

SoClean³

Automated Supplemental Sleep Equipment Maintenance System

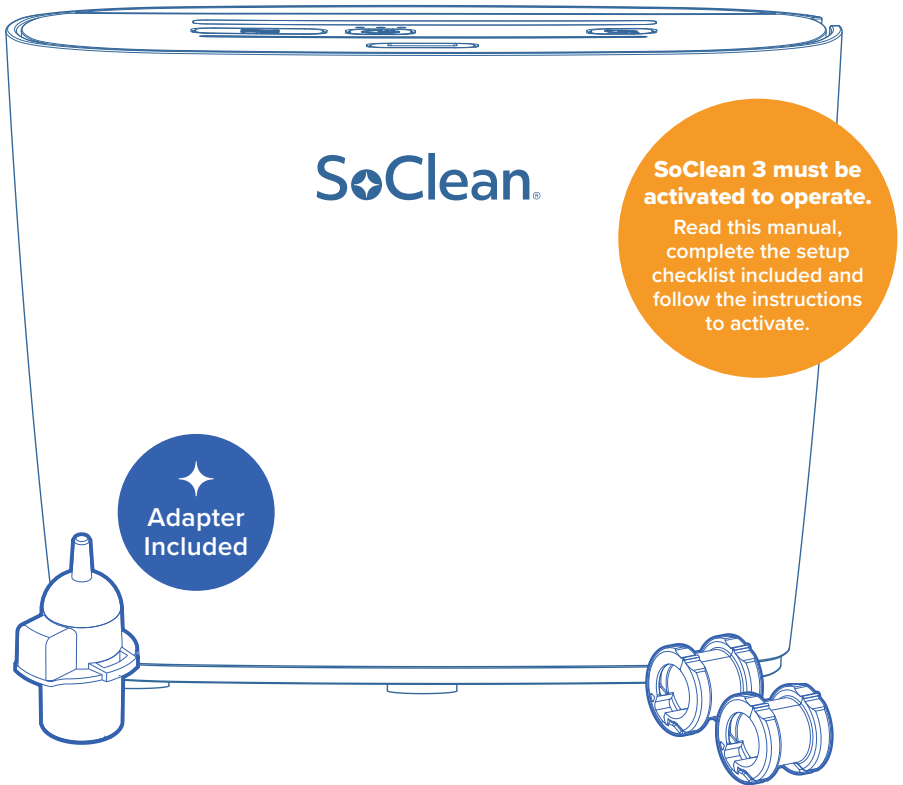

USER MANUAL

CONTAINS ONE SOCLEAN ADAPTER
PLUS, 2 - Hose Sleeves [For use with 12 mm hose]

SC1400



THANK YOU FOR CHOOSING SOCLEAN!

We hope you enjoy making SoClean 3 part of your daily maintenance routine.

TABLE OF CONTENTS

Overview	4
Warnings and Precautions	6
Learn About Ozone	9
Your SoClean 3: Parts, Buttons & Indicator Lights	11
Setting Up Your SoClean 3	19
Powering Your SoClean	20
Installing the Filter	22
Wash, Rinse and Dry Your Sleep Equipment Hose and Mask	24
Connecting the Adapter	26
Setup Checklist & Device Activation	28
Using Your SoClean 3	29
Operating a Maintenance Cycle	29
Using the Hose Sleeve	32
Setting a Delay for Your Maintenance Cycle	34
Fresh Air Cycle	36
Canceling a Cycle	37
Reconnecting Your Sleep Equipment	38
Maintenance	40
General Troubleshooting	42
Warranty Information	50



OVERVIEW

Indications for Use, Contraindications, and Specifications

INDICATIONS FOR USE

The SoClean 3 device is intended to be used to supplement maintenance procedures for home use sleep equipment masks and hoses.

CONTRAINDICATIONS FOR USE

Persons with underlying lung diseases, such as asthma and chronic obstructive pulmonary disease (also known as COPD, which includes emphysema and chronic bronchitis), and those with cardiovascular disease may be sensitive to ozone and should consult with their health care professional before using this product.

CAUTION: Safety in pregnant or breastfeeding women and children under the age of 22 have not been established. Consult with your health care professional before using this product.

Read this instruction manual before operating this device.

The SoClean 3 device should be used only according to the procedures described in this manual. If it is used in a manner not specified by SoClean[®], the safety protection provided by the equipment may be impaired.

SPECIFICATIONS

Model Number

SC1400

Operating Environmental Conditions

Indoor use only.
Temperature: 50°F to 100°F (10°C to 38°C)
Relative Humidity: 15% to 75%
Altitude: sea level to 8,500' (2,591 m);
Air Pressure Range 101.3 kPa to 73.8 kPa

Physical Characteristics

Dimensions: 9.49" x 7.12" x 7.36"
(241 x 181 x 187 mm)
Weight: 3.65 lbs. (1.65 kg)
Cord Length: 4' 11" (1.5 m)

Electrical Characteristics

AC Adapter Input: AC 100~240V, 50/60HZ, 0.5A
AC Adapter Output: DC 12V, 1.5A Max
Power Consumption: 18W Max
USB Charging Port Output: DC 5V, 0.5 A Max

Storage and Transport Conditions

Temperature: -4°F to 131°F (-20°C to +55°C)
Humidity: 15% to 95% non-condensing humidity
Pressure: 106kPa to 70kPa
[Sea level to 10,000' (3048m)]

Ozone Cycle

75 minutes

Ozone Concentration

440 ppm maximum from ozone generator

Electromagnetic Compatibility

The SoClean 3 complies with all applicable electromagnetic compatibility requirements (EMC) according to IEC 60601-1-2:2014, for residential, commercial, and light industry environments. If electrical interference is suspected during operation, contact SoClean Customer Care.

Sleep Equipment Hose

Dimensions Compatibility

For use with hose outside diameter dimensions between 0.715 and 0.935 inches (18.15 and 23.75 mm) and lengths up to 6 feet 6 inches (3.07 meters).

A 12 mm hose diameter will require a SoClean Hose sleeve.

USB Port

This port is provided only for USB charging. Maximum USB charging cord length: 10 ft. (3 m).

OZONE LEAKAGE

The SoClean 3 meets 21 C.F.R. § 801.415 for the maximum allowable ozone accumulation of not more than 0.05 parts per million when operated in a room larger than 70 square feet with 8-foot or higher ceilings.

PACKAGING SYMBOLS

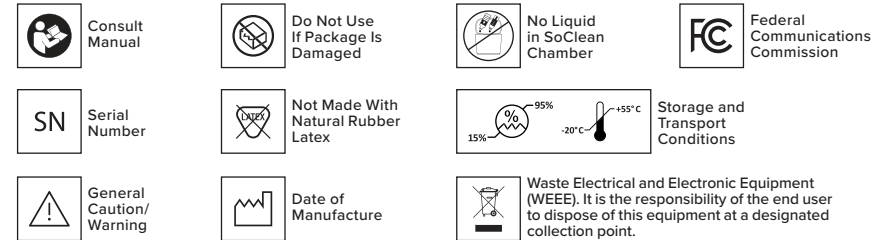

DISPOSAL INFORMATION: Safe disposal of the device: Follow the local, state, and national governing ordinances and recycling instructions regarding disposal or recycling of the device and device components at the end of the expected service life.

FCC Notice Part 15:

This device complies with part 15 of the FCC rules. Operation is subject to the following two conditions: (1) This device may not cause harmful interference, and (2) this device must accept any interference received, including interference that may cause undesired operation.











NOTE: This equipment has been tested and found to comply with the limits for a class B digital device, pursuant to part 15 of the FCC rules. These limits are designed to provide reasonable protection against harmful interference in a residential installation. This equipment generates, uses, and can radiate radio frequency energy and, if not installed and used in accordance with the instructions, may cause harmful interference to radio communications. However, there is no guarantee that interference will not occur in a particular installation. If this equipment does cause harmful interference to radio or television reception, which can be determined by turning the equipment off and on, the user is encouraged to try to correct the interference by one or more of the following measures:











- Reorient or relocate the receiving antenna.
- Increase the separation between the equipment and receiver.
- Connect the equipment into an outlet on a circuit different from that to which the receiver is connected.
- Consult SoClean Customer Care for help.

CAUTION: Changes or modifications not expressly approved by the party responsible for compliance could void the user's authority to operate the equipment.

CAUTION: This equipment complies with FCC/IC RSS-102 radiation exposure limits set forth for an uncontrolled environment. To maintain compliance with the FCC and IC RF exposure guidelines, place the unit at least 20 cm away from nearby persons.

Warnings and Precautions

-  **WARNING:** Discontinue use and call your health care professional in the event that you experience any respiratory or cardiac symptoms.
-  **WARNING:** Keep away from children.
-  **WARNING:** When operating your SoClean 3 per the instructions for use, if there is a noticeable scent of ozone or other unfamiliar odor or you experience headache, cough, or shortness of breath, leave the room for 4 hours. Contact SoClean Customer Care before running your machine again.
-  **WARNING:** The Ozone Tube must always be connected to the SoClean Adapter and the back of the SoClean 3 unit when operating the SoClean.
-  **WARNING:** Do not inhale from the Ozone Tube or the Ozone Outlet on the back of the device. Do not breathe through the mask if the SoClean 3 is operating a Maintenance Cycle.
-  **WARNING:** Do not forcibly open the SoClean 3 Lid before the Cycle completes.
-  **WARNING:** Do not submerge the SoClean 3 device in water or use chemical cleaners on or in your SoClean 3. Keep away from water sources, including rain, bathtubs, sinks, and pools. To clean, wipe inside and outside with a damp cloth.
-  **WARNING:** Do not put liquids into the SoClean Chamber.
-  **WARNING:** Do not disassemble or modify your SoClean device or accessories.
-  **WARNING:** If the SoClean system is dropped, it may become damaged. Regularly inspect the SoClean 3 for physical damage, such as cracks or broken structure, damaged gaskets, and cracks in the Ozone Tube or sleep equipment hose. Discontinue use if damage is detected and contact SoClean for assistance.
-  **WARNING:** To reduce the chance of tripping, place your sleep equipment and SoClean along with all cords, tubes and hoses out of the way of any area you may walk.

-  **CAUTION:** Do not place any flammable or ignitable items on top of the SoClean 3 device. Do not use in explosive air environments, near gas vapors, or other flammables, etc.
-  **CAUTION:** Discontinue use of your SoClean 3, consult your health care professional, and contact SoClean Customer Care if acne or a rash develops along the mask contact line.
-  **CAUTION:** Ensure all tubing and hoses are free of kinks prior to operating the SoClean 3.
-  **CAUTION:** Rest the flexible part of the sleep equipment hose, not the rigid mask connector, in the Hose Slot to ensure a proper seal.
-  **CAUTION:** Inspect the SoClean 3 Lid and Hose Gaskets for visible damage before operating a Maintenance Cycle.
-  **CAUTION:** Do not share a SoClean 3 between sleep equipment users. Your SoClean 3 is to be used by one user.
-  **CAUTION:** In the event of loss of power, rerun the entire Maintenance Cycle to make sure the sleep equipment hose and mask have been maintained properly.
-  **CAUTION:** Wash your sleep equipment mask and hose according to the sleep equipment manufacturer's recommended method and interval. Use the SoClean 3 for daily supplemental maintenance of your sleep equipment mask and hose.
-  **CAUTION:** Do not use incompatible materials in the SoClean 3 such as memory foam, natural rubber, or nylon. Headgear often contains incompatible materials for your SoClean 3. Remove headgear before placing mask in the Maintenance Chamber.
-  **CAUTION:** Ensure there are no obstructions to the filter exhaust. Keep the area behind the SoClean 3 clear of clutter and soft objects.

Compatible Masks and Hoses

SLEEP EQUIPMENT HOSE COMPATIBILITY

For use with hose diameters of 15 mm and 19 mm and length up to 6' 6".

A 12 mm hose diameter will require a SoClean Hose sleeve [included].



MATERIAL COMPATIBILITY

Sleep equipment masks and hoses are made from a variety of materials. SoClean has tested sleep equipment masks and hoses for material compatibility with the ozone maintenance process.

While most sleep equipment masks and hoses are made of compatible materials, the following materials should not be used with the SoClean 3: memory foam, natural rubber, or nylon.

Sleep equipment mask and hose materials may discolor naturally over time and with use, which is why the sleep equipment manufacturers recommend replacing these components at regular intervals. The SoClean 3 is safe to use with sleep equipment masks and hoses even if you notice some discoloration.

CAUTION: Do not use incompatible materials in the SoClean 3 such as memory foam, natural rubber, or nylon. Headgear often contains incompatible materials for your SoClean 3. Remove headgear before placing mask in the Maintenance Chamber.

How does my SoClean 3 Work? Learn About Ozone

SoClean 3 uses ozone. Ozone is contained within the system and is in contact with your sleep equipment hose and mask during the Maintenance Cycle.

SoClean 3 is designed to produce a sufficient level of ozone for maintenance of your sleep equipment hose and mask. The smell of ozone is detectable at low concentrations by some people and you may smell ozone briefly during the Maintenance Cycle.

Ozone naturally breaks down into oxygen in a short amount of time. Your SoClean 3 safely contains ozone within the system until it has converted back to oxygen. The Filter accelerates the process of converting ozone in your SoClean 3 Chamber and your sleep equipment hose and mask into fresh air before the completion of a Maintenance Cycle.

WARNING: When operating your SoClean 3 per the instructions for use, if there is a noticeable scent of ozone or other unfamiliar odor or you experience headache, cough, or shortness of breath, leave the room for 4 hours. Contact SoClean Customer Care before running your machine again.

WARNING: If you are experiencing headaches/migraines, or symptoms such as cough or discomfort in your nose or throat discontinue use and call your health care provider.

WARNING: Discontinue use and call your health care provider if you experience any cardiopulmonary symptoms.

WARNING: If the SoClean system is dropped, it may become damaged. Regularly inspect the SoClean 3 for physical damage, such as cracks or broken structure, damaged gaskets, and cracks in the Ozone Tube or sleep equipment hose. Discontinue use if damage is detected and contact SoClean for assistance.

CAUTION: Discontinue use of your SoClean 3, consult your health care provider and contact SoClean Customer Care if acne or a rash develops along the mask contact line.

WHAT'S INCLUDED



SOCLEAN ADAPTER

Compatible with most sleep equipment hoses.



Your SoClean 3: Parts, Buttons & Indicator Lights

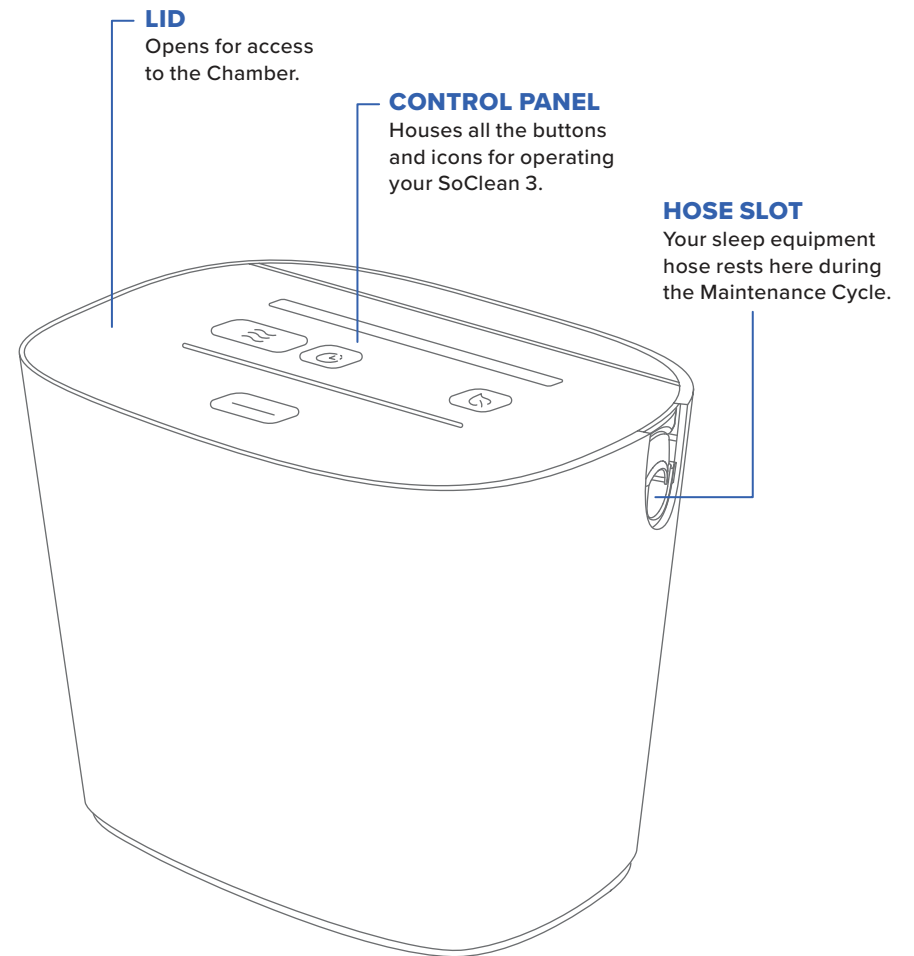

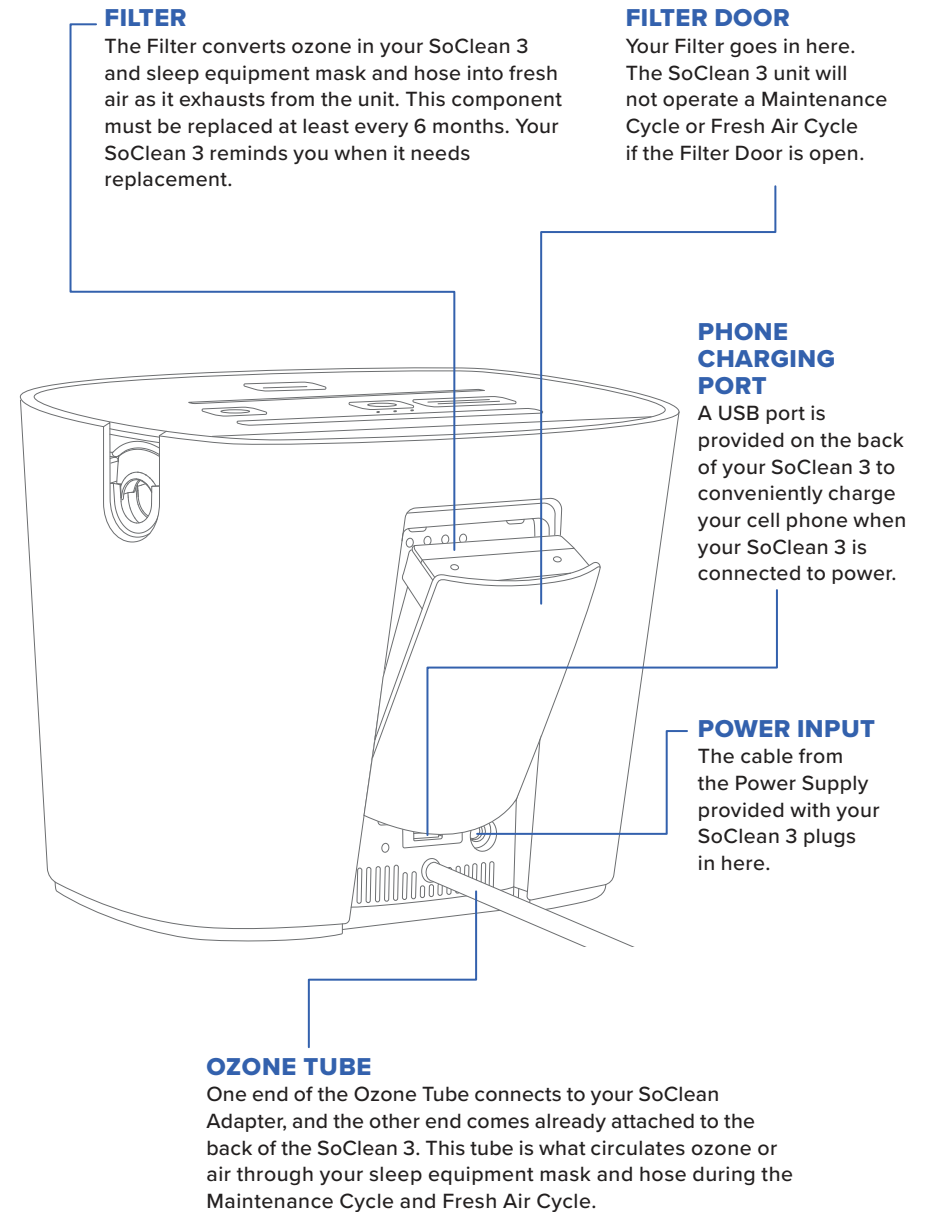
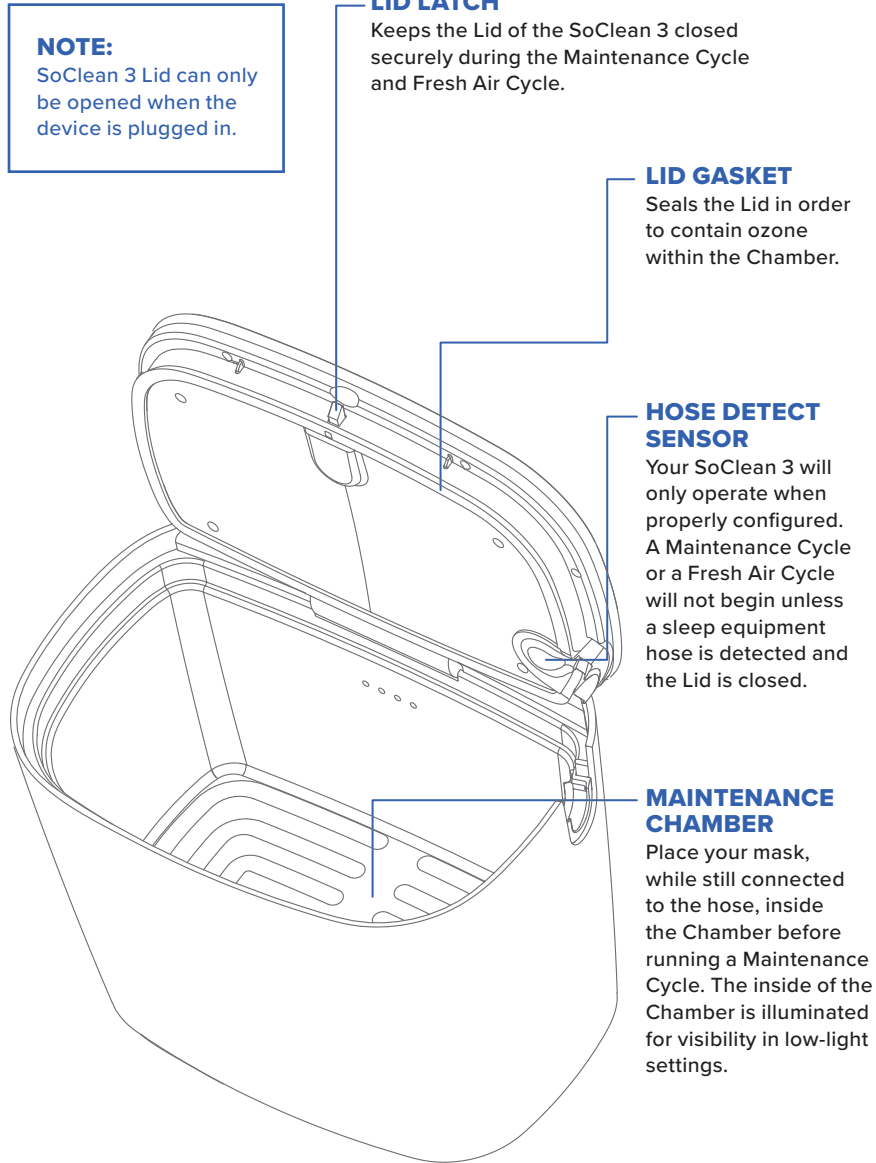

CONTROL PANEL

Get to know the **buttons** used to control the device operation and the **icons** that will tell you what is happening.

BUTTONS

There are 4 buttons on the Control Panel that are used to operate your SoClean 3. Buttons illuminate **blue** when any one button is pressed to help with visibility in low-light conditions.

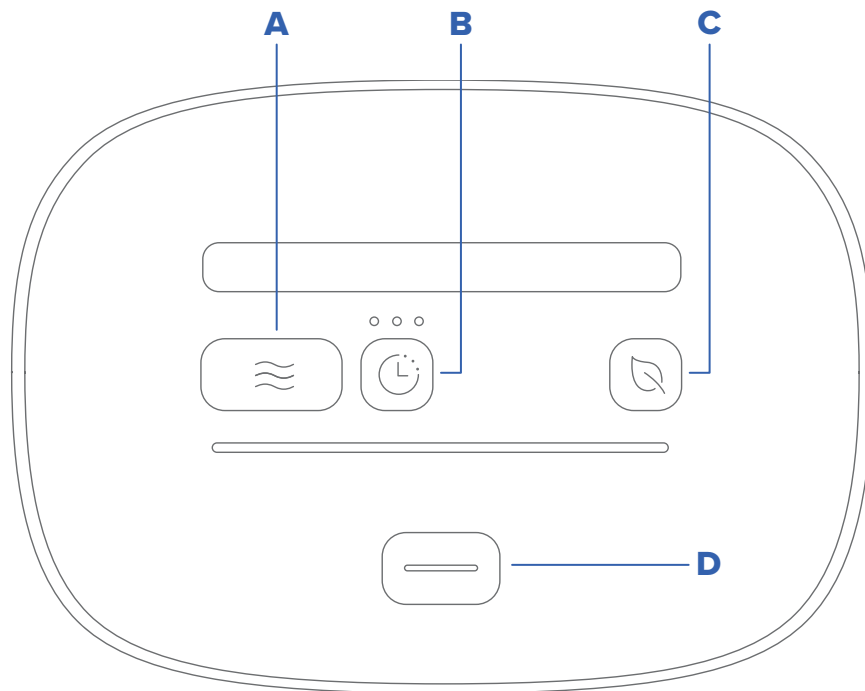

There is no power button on your SoClean 3. The device is connected to power and “on” when the Power Supply is plugged into your SoClean 3 and the electrical outlet.

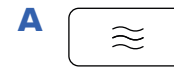

MAINTENANCE CYCLE

Starts the maintenance process with a single push of the button.

Your mask and hose must be present in the SoClean 3 with the Lid closed to operate the Maintenance Cycle.



CYCLE DELAY

Used to set a 2, 4, or 8 hour delay to the start of your Maintenance Cycle.

NOTE: The system automatically returns to the default setting of **No Delay** after each use.



FRESH AIR CYCLE

Runs air through the system to freshen your sleep equipment mask and hose with the push of a button.

NOTE: The Fresh Air Cycle does not maintain your sleep equipment mask and hose.

Your mask and hose must be present in the SoClean 3 with the Lid closed to operate the Fresh Air Cycle.



LID OPEN





Opens the Lid when the device is connected to power. This button can also be used to cancel an active Maintenance Cycle by pressing and holding for 5 seconds.

NOTE: If canceling a Cycle, Lid cannot be opened until Cycle Complete Icon illuminates.

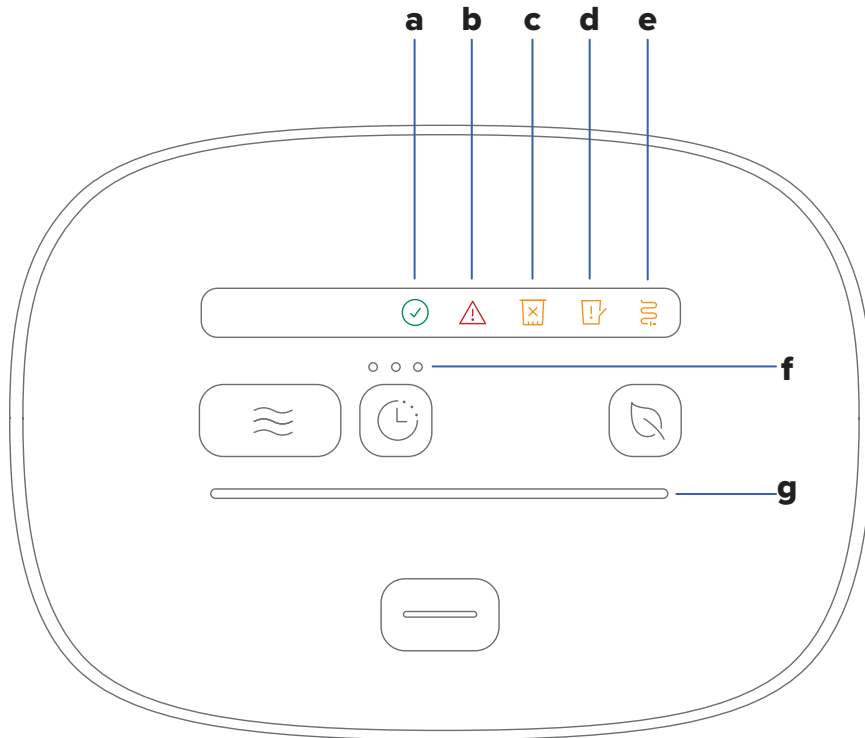
INDICATOR LIGHTS

There are 7 illuminated indicator lights on the Control Panel that the SoClean 3 uses to communicate with you. The icons are off if the device is idle and operating normally. See the notes to follow about why these icons may illuminate and when you can expect to see them.



- a**  **CYCLE COMPLETE**
Solid Green
 Indicates that either a Maintenance Cycle or Fresh Air Cycle is complete and that the Lid can be opened.
- b**  **FAULT/UNABLE TO RUN**
Solid Red/Flashing Red
 Indicates when your SoClean 3 has detected an internal issue. See troubleshooting guide.
- c**  **FILTER ISSUE**
Flashing Amber
 Indicates that it is time to order a new Filter. From the time it begins to flash amber, you have 30 days or 30 uses (whichever comes first) to replace the Filter. You can still use your SoClean 3 to maintain your sleep equipment hose and mask during this time.
Solid Amber
 See troubleshooting guide.
- d**  **FILTER DOOR ISSUE**
Solid Amber
 Indicates that the Filter Door is not completely closed. Check your Filter Door and open/close it securely.
- e**  **HOSE NOT DETECTED**
Solid Amber
 Indicates that your sleep equipment hose is not present or detected when the Lid is closed.
Flashing Amber
 Indicates an error detecting the hose or in process of detecting a hose. This may be the first time the SoClean 3 has been powered on or there has been loss of power to the device. Open and close Lid with mask and hose installed to continue.
- NOTE:** Your SoClean 3 will not operate a Maintenance Cycle or Fresh Air Cycle if your mask and hose are not installed or detected in the unit with the Lid closed.

f ○○○ **2, 4, 8 HOUR CYCLE DELAY INDICATOR LIGHTS**

Flashing Blue

Indicates that the Cycle Delay can be changed by pressing the **Cycle Delay** button .

NOTE: Your mask and hose must be installed with the Lid closed to modify and activate the Cycle Delay.

Solid Blue

Indicates if a Cycle Delay has been programmed.

Three indicator lights are provided.

One light illuminated = 2 hr delay selected

Two lights illuminated = 4 hr delay selected

Three lights illuminated = 8 hr delay selected

No lights illuminated = no cycle start delay selected (default)

g  **CYCLE PROGRESS BAR**

Progressive Blue

Gradually turns **blue** from left to right as an indication of progress for a Maintenance Cycle or Fresh Air Cycle.

 **Flashing Blue**

A Cycle cancellation is in progress.

 **Solid Red**

Indicates that an active Maintenance Cycle has been interrupted (example: temporary loss of power).

NOTE: During this time, your SoClean 3 is pumping air through the system to remove ozone.

Setting Up Your SoClean 3



1 POWERING YOUR SOCLEAN 3

A **Power Supply** is provided to safely power your SoClean 3. You will need access to an electrical outlet near your SoClean 3 to power your SoClean 3 in a well ventilated room.



DO NOT place the power cord inside the device chamber. The Lid will not open unless the device is powered.

A Locate an electrical outlet near your SoClean 3 setup.
NOTE: It is okay to plug into a power strip, if needed.

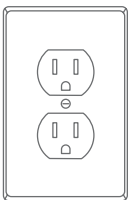

WARNING: Avoid a tripping hazard.

B Locate your **Power Supply** in the Welcome Kit as shown. Remove the **Power Supply** from the box.

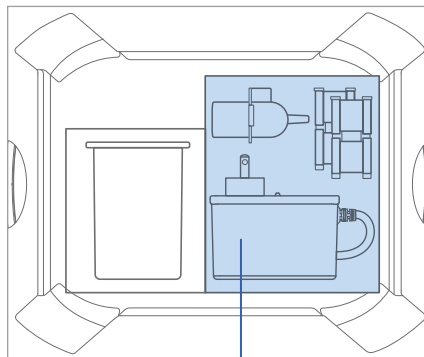

Power Supply

C Plug the **Power Supply** into the back of your SoClean 3 as shown.

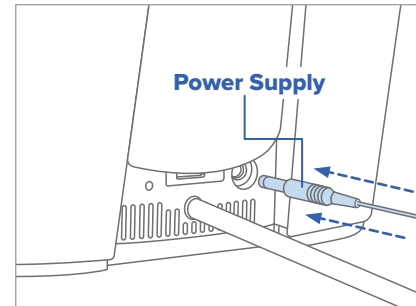

D Plug the **Power Supply** into an electrical outlet or power strip.

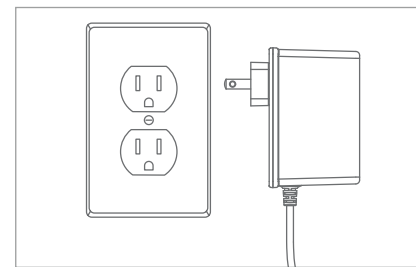

NOTE: Your SoClean 3 does not have a power switch to turn the device on/off. When initially connected to power, the lights on your SoClean 3 will flash a pattern that you may not see if you are not looking at the device immediately after it is connected to power. The SoClean 3 enters a low-power “sleep” mode when not in use and fully powers when you press any of the buttons on the Control Panel.

At this point in your SoClean 3 setup, your Control Panel should appear as shown.

NOTE: The Filter Issue icon is illuminated and the Hose Not Detected icon is flashing on your Control Panel because the Filter is not yet installed and the sleep equipment mask/hose has not been placed into the SoClean 3 with the Lid closed.



2 INSTALLING THE FILTER



The **Filter** converts ozone back to oxygen as it leaves the SoClean 3 **Chamber**. With normal usage of one Maintenance Cycle per day, the **Filter** needs to be replaced approximately every 6 months or when indicated by your device. To order a replacement **Filter**, go to your authorized reseller or SoClean.com. The following steps are used to install the **Filter** in your SoClean 3.

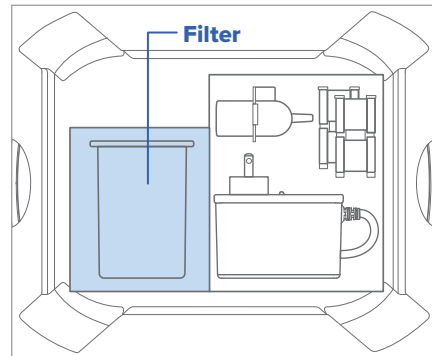

A Locate and remove the **Filter** from the box.

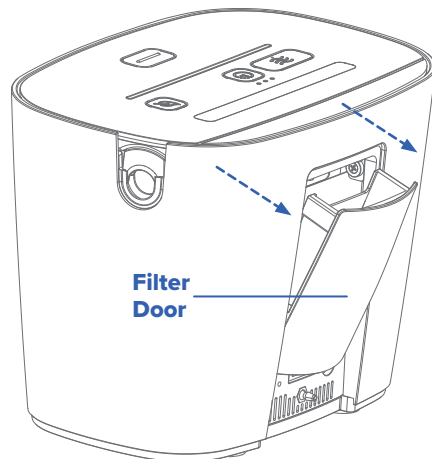

B Locate the **Filter Door** on the back of your SoClean unit and open it by pulling the top edge of the **Filter Door** away from the unit.

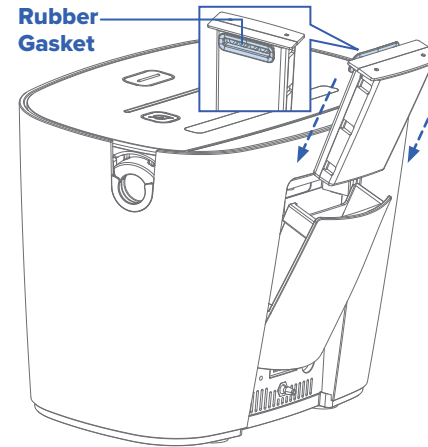

C Insert the **Filter** into the slot with the blue **Rubber Gasket** facing inward as shown.

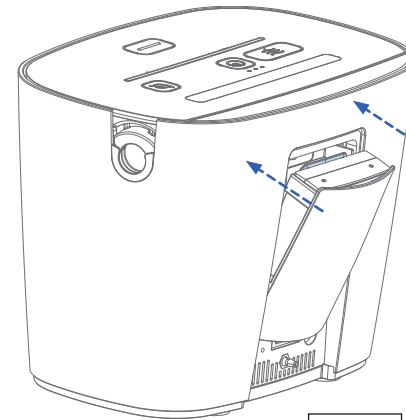

D Push the **Filter Door** until it is fully closed.

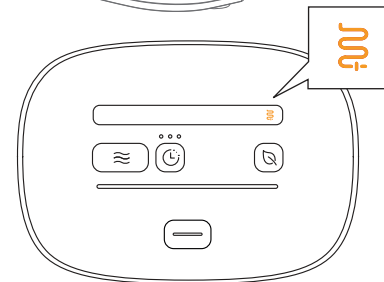

At this point in your SoClean 3 setup, your Control Panel should appear as shown.

NOTE: The Hose Not Detected icon is flashing on your Control Panel because a mask/hose has not been placed into the SoClean 3 with the Lid closed.

NOTE: If the Filter icon or Filter Door icon is flashing on your Control Panel, remove and reinstall the Filter, making sure the filter door is fully closed.

3 WASHING YOUR SLEEP EQUIPMENT HOSE AND MASK

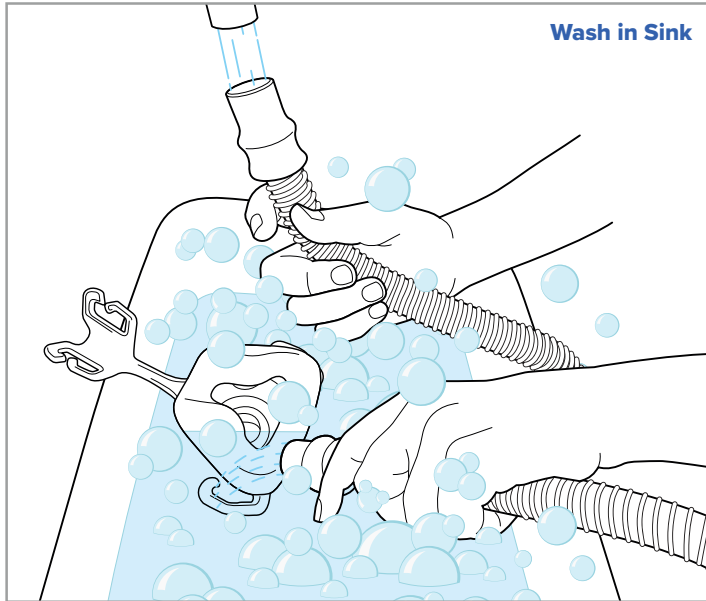

Wash, rinse, and dry your hose and mask as recommended by the manufacturer.

Your SoClean 3 should be used as a supplement to your cleaning routine, not a replacement.

Washing removes oils, films, debris and other build up that can naturally form on your mask and hose from use.

Using the Hose and Mask Adapter with your SoClean 3



Connecting the Adapter

IMPORTANT: This adapter needs to fit snugly. If the fit appears too tight, do not force adapter into tubing. If the adapter is loose, call Customer Care at 866-501-3705.

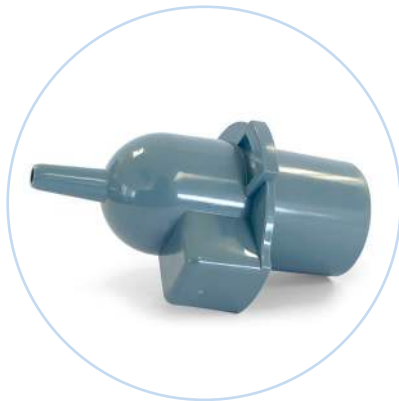

SoClean Adapter



Shown connected to popular sleep equipment hoses.

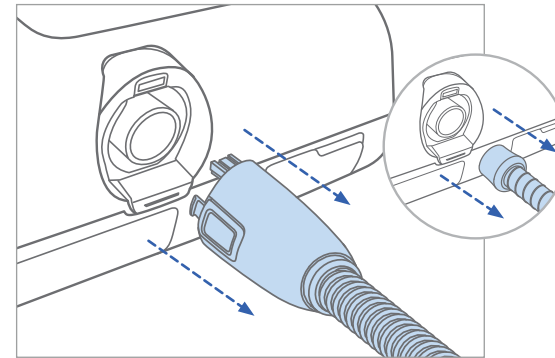

1

Remove the hose from your sleep equipment.

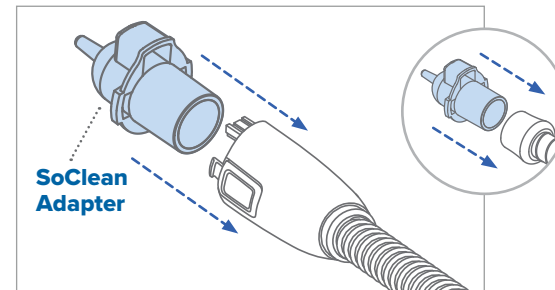

2

Install the SoClean Adapter onto the hose.

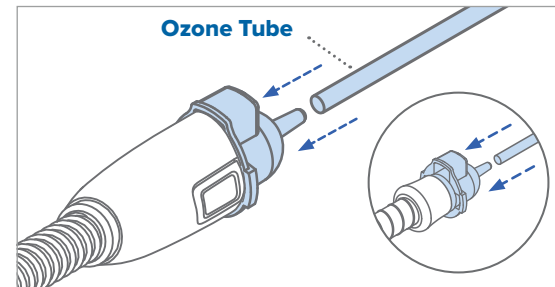

3

Connect **Ozone Tube** to the **SoClean Adapter**.

Move on to Device Activation.



WARNING: The **Ozone Tube** must always be connected to the SoClean Adapter and the back of the SoClean 3 unit when operating the SoClean 3.



Setup Checklist & Device Activation

Complete the steps below in order to use your SoClean 3

- SoClean is powered on (page 20)
- Filter is installed (page 22)
- Sleep equipment hose and mask are washed in sink and dried before first use (page 24)
- SoClean Adapter is installed on sleep equipment hose
- Ensure the Ozone Tube is connected to the back of the SoClean 3 and the SoClean Adapter
- Sleep equipment hose is still connected to mask
- ONE-TIME DEVICE ACTIVATION:** The Lid must be closed and the mask and hose outside the Chamber. Firmly press the Control Panel buttons in the following order:



If the Cycle Complete icon is green ✓, your device is ready to use.

If the activation was unsuccessful, press the **Lid Open** button  to open the Lid. Close Lid. **Restart DEVICE ACTIVATION.**

Using Your SoClean 3

Once you have completed the setup steps, you are ready to begin the daily maintenance of your sleep equipment mask and hose with your SoClean 3.

1 OPERATING A MAINTENANCE CYCLE

The SoClean 3 can be used daily to supplement your manufacturer recommended hose and mask cleaning routine.

Wait a minimum of 30 minutes between completion of the Cycle and use of the sleep equipment mask and hose.

A Ensure your SoClean 3 is ready for use by completing the steps on the setup checklist.

STOP: ensure you are following your manufacturer's recommendation to properly wash and dry your sleep equipment hose and mask before first use of SoClean 3 and as part of your ongoing cleaning routine (page 24).

B Press the **Lid Open** button  to open the Lid.

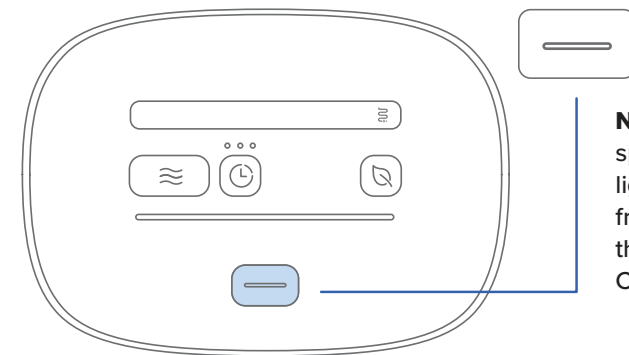

NOTE: The Lid will spring open and light will illuminate from the inside of the bottom of the Chamber.



WARNING: The **Ozone Tube** must always be connected to the SoClean Adapter and the back of the SoClean 3 unit when operating the SoClean 3.



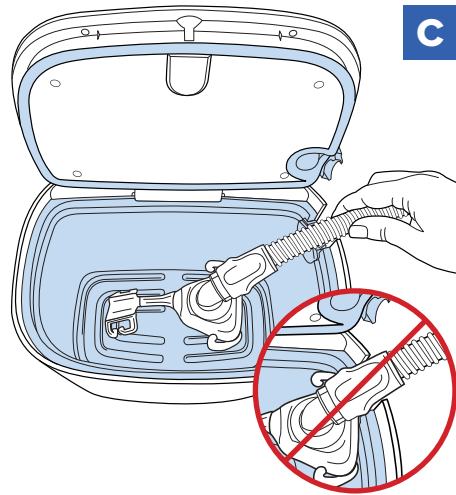

C Make sure the sleep equipment hose is connected to the SoClean Adapter and the Ozone Tube is properly connected to the Adapter and to the back of the SoClean 3.

Place your mask into the Chamber and route the mask hose through the Hose Slot.

⚠ **CAUTION:** Ensure all tubing and hoses are free of kinks prior to operating the SoClean 3.

⚠ **CAUTION:** Rest the flexible part of the hose, not the rigid mask connector, in the Hose Slot to ensure a proper seal.

See Step 2 if your hose requires a Hose Sleeve.

Push the Lid down until it latches shut.

NOTE: Some head gear contains nylon which is not compatible with ozone. It is recommended to remove head gear before placing the mask into the Chamber.

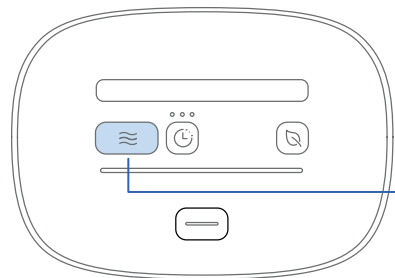

D To run the Maintenance Cycle immediately, press the **Maintenance Cycle** button  to start.

You should hear the ozone generator and air pump turning on and off periodically over the 1 hour and 15 minute Maintenance Cycle.

The **Maintenance Cycle** button  will illuminate **blue** to indicate the Maintenance Cycle is operating.

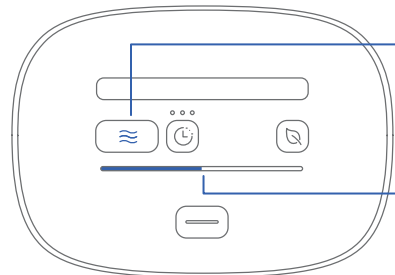



The **Progress Bar** on the Control Panel will illuminate **blue** from left to right as the cycle proceeds to completion.

NOTE: It is important to leave your mask and hose in the SoClean 3 for the complete Cycle duration to ensure full maintenance of your sleep equipment mask and hose. Leave the room for the duration of the Cycle.

If you need to remove your sleep equipment mask and hose before the Maintenance Cycle is complete, see the “Canceling a Cycle” section.

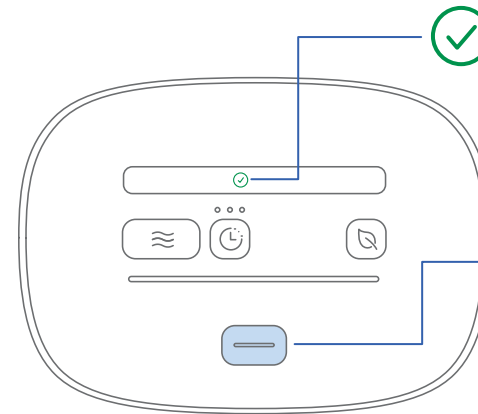
The SoClean will operate the air pump and circulating fan for the last 12 minutes of the Cycle duration to move fresh air through the system.



E At the end of the Maintenance Cycle, the **Cycle Complete** icon  will light up **green**.

You can now press the **Lid Open** button  to remove your mask and hose. Wait a minimum of 30 minutes between completion of the Cycle and use of the sleep equipment mask and hose.

Your sleep equipment mask and hose are ready for use!

⚠ **CAUTION:** In the event of loss of power to your home or the SoClean 3 device during a maintenance cycle, you may want to rerun the entire Maintenance Cycle to make sure your sleep equipment hose and mask have been properly maintained.

IMPORTANT: The SoClean 3 device will not operate without the mask and hose present in the securely closed Chamber. Additionally, the SoClean 3 will not operate if the Filter is not present with the Filter Door closed.

2 USING THE HOSE SLEEVE [OPTIONAL]

The SoClean requires a snug fit around the hose when placed into the hose slot and the lid is closed. If there is space around the hose and this is not achieved, the SoClean will not operate.

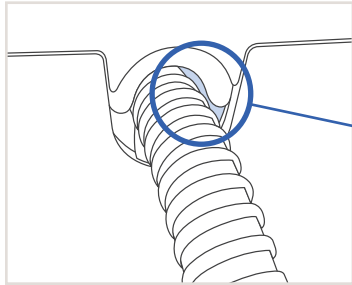

If there is visible space around the hose when placed in the hose slot, you may be using a 12 mm hose and require the Hose Sleeve be installed.

The Hose Sleeve is required if you use a 12 mm hose. It is not compatible with 15 mm or larger diameter hoses.

An extra sleeve is included in the event of sleeve breakage. You will only use one Hose Sleeve at a time.

The images below are actual size and can be used to determine which hose you have.

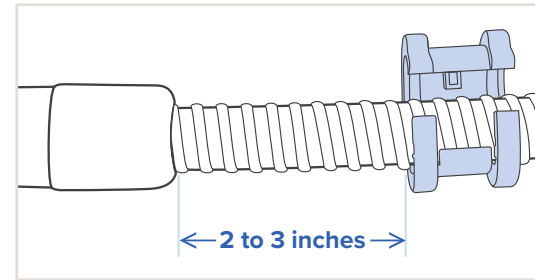

A Position the Hose Sleeve 2 to 3 inches from the connector.

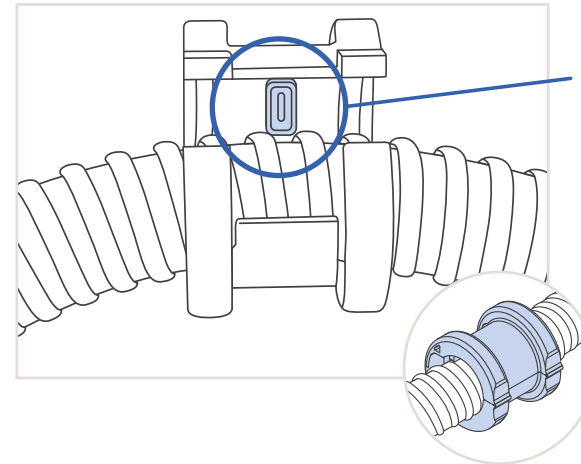

B Position the hose on the Nub side of the Hose Sleeve. Slide the hose until the Sleeve “clicks” into place between two of the hose ribs and close the Sleeve.

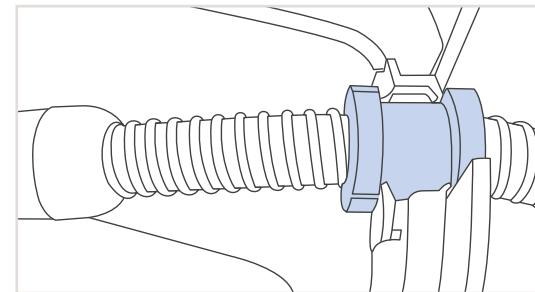

C Line up the Hose Sleeve with the gasket, place it in the Hose Slot and shut the lid.

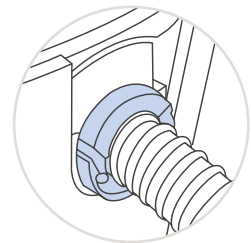

3 SETTING A DELAY FOR YOUR MAINTENANCE CYCLE

If you would like the SoClean 3 to operate at a more convenient time, you can delay your Maintenance Cycle by 2, 4, or 8 hours.

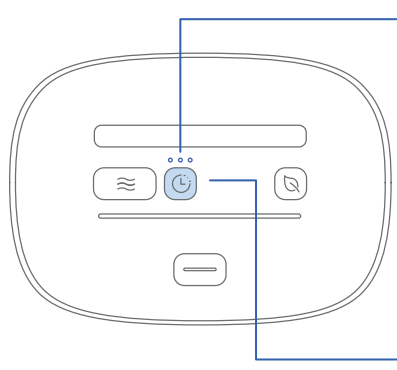



PRESS	INDICATION	DELAY
1 time	1 blue indicator	2-hour
2 times	2 blue indicators	4-hour
3 times	3 blue indicators	8-hour
4 times	No blue indicator	No delay



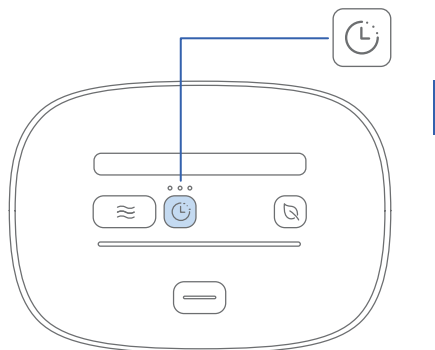



- No delay (default)
- 2-hr delay selected
- 4-hr delay selected
- 8-hr delay selected



NOTE: Your mask and hose must be in your SoClean 3 with the Lid closed to select or adjust a Cycle Delay.

A When your mask, hose, and filter are properly installed and the Lid is closed, all three buttons will briefly light up solid **blue**. Press the **Cycle Delay** button  to select the delay time. The **Cycle Delay** button  will flash **blue** for a few seconds during which time the Cycle Delay can be changed.

B The Cycle Delay time is selected by pressing the **Cycle Delay** button  until the desired number of lights are lit, as indicated by the **blue** indicator lights ○○○ above the **Cycle Delay** button  and then pressing the **Maintenance Cycle** button  to confirm the setting. If you've gone past the correct number of lights, continue to press the **Cycle Delay** button  until the desired delay is set.

Allow approximately 1 second between button presses when selecting the Cycle Delay. The delay timer will start immediately after pressing the **Maintenance Cycle** button .

NOTE: If the **Maintenance Cycle** button  is not pushed within 10 seconds of the last **Cycle Delay** button  press, the Cycle Delay setting will time out and a delayed Maintenance Cycle will not occur.

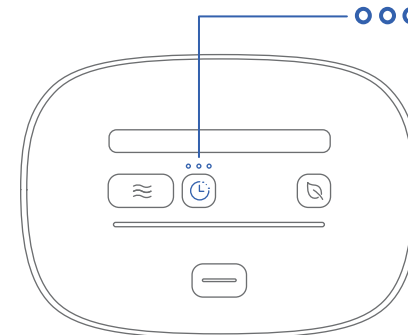

During the delay period, the **Cycle Delay** indicator lights above the button will illuminate **blue** until the Maintenance Cycle starts.

Once the selected Cycle Delay time has elapsed, the Maintenance Cycle will automatically begin. Leave the room for the duration of the Cycle.

To cancel the Cycle Delay after it's set, simply open the lid.

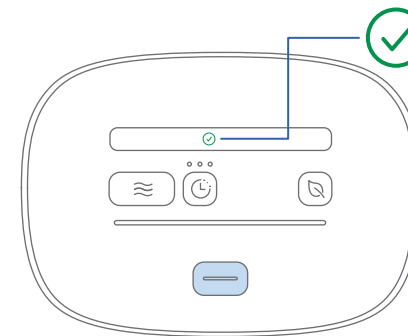

C At the end of the Cycle Delay and Maintenance Cycle, the **Cycle Complete** icon  will light up **green**. You can now open the Lid and remove your mask and hose.

Wait a minimum of 30 minutes between completion of the Cycle and use of the sleep equipment mask and hose.

NOTE: The system automatically returns to the default setting of **No Delay** after each use. If power is lost during a delayed cycle it will be canceled.

4 FRESH AIR CYCLE [OPTIONAL]

The Fresh Air Cycle can be used daily to freshen the air in your mask and hose before use. Typically, your mask and hose will still be in your SoClean 3 from a Maintenance Cycle and the Fresh Air Cycle can be started with a simple one-button push. The Fresh Air Cycle does not maintain your sleep equipment mask and hose.

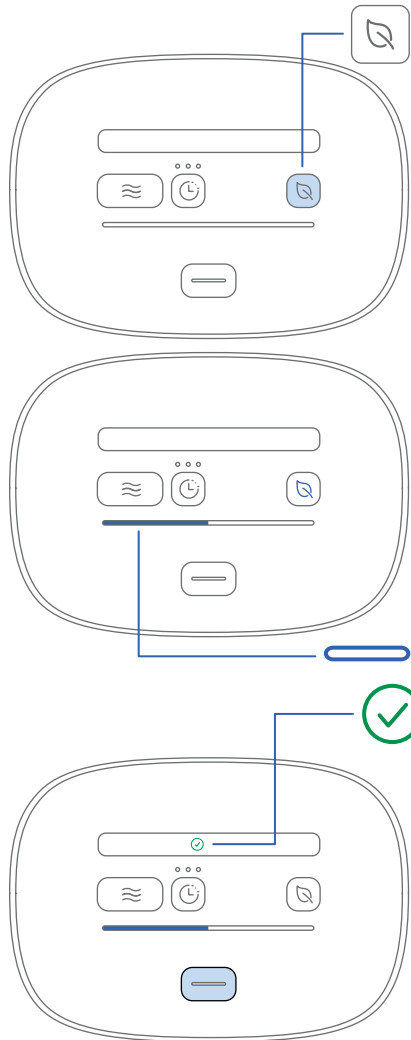

A Place your mask and hose in your SoClean 3 and press the **Fresh Air Cycle** button  to initiate the process.

The Fresh Air Cycle will take approximately 5 minutes to complete. During the Fresh Air Cycle, the **Fresh Air Cycle** button  will illuminate **blue** to indicate the Fresh Air Cycle is operating. The **Progress Bar** on the Control Panel will progressively illuminate **blue** as the cycle proceeds to completion.

NOTE: Running a Fresh Air Cycle does not reduce the life of the Filter.

B At the end of the Fresh Air Cycle, the **Cycle Complete** icon  will light up **green**. You can now open the Lid and remove your mask and hose.

NOTE: You can run only 3 consecutive Fresh Air Cycles before you must run a Maintenance Cycle. This ensures that your sleep equipment mask and hose are properly maintained.

5 CANCELING A CYCLE

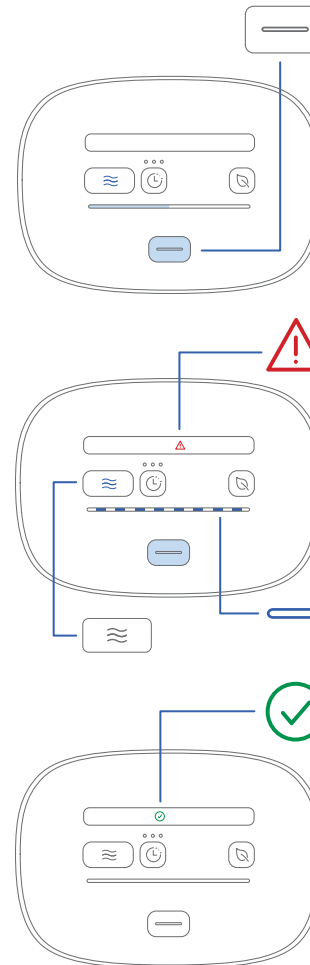

If you need to remove your sleep equipment mask and hose while an active Maintenance Cycle is taking place, you can cancel the cycle.





A Press and hold the **Lid Open** button  for approximately 5 Seconds.

The SoClean 3 will pump air through the system for approximately 15 minutes after the Maintenance Cycle is canceled in order to clear ozone from your sleep equipment mask and hose.

While the Maintenance Cycle cancellation is in progress, the following will illuminate:

- **Fault/Unable to Run** icon  will flash **red** for nine seconds.
- **Maintenance Cycle** button  will illuminate **blue**
- **Progress Bar** on the **Control Panel** will flash **blue**

The **Lid** will remain locked until the cancellation is complete.

B At the end of the Maintenance Cycle cancellation, the **Cycle Complete** icon  will light up **green**. The Maintenance Cycle was successfully canceled. You can now press the **Lid Open** button  and remove your mask. Wait a minimum of 30 minutes between completion of the Cycle and use of the sleep equipment mask and hose.

Your sleep equipment mask and hose may not have been fully maintained.

⚠ WARNING: Do not forcibly open the SoClean 3 Lid before the Cycle completes.

Maintenance

CLEANING YOUR SOCLEAN 3

To clean, wipe the interior and exterior of your SoClean 3 device with a slightly damp cloth or sleep equipment wipes. Please note that liquid cleaners should be used only on your sleep equipment hose and mask and should not be used on or in the SoClean 3 device. Do not submerge the SoClean 3 device in liquid or use chemical cleaners. Do not put water inside the SoClean 3 device.

PRE-WASH YOUR SLEEP EQUIPMENT HOSE AND MASK

Wash your sleep equipment hose and mask according to the manufacturer's recommended method and interval. In addition, do this prior to using the SoClean 3 for the first time or when introducing a new hose and mask.

VISIBLE CRACKS OR DAMAGE

⚠ WARNING: If the SoClean system is dropped, it may become damaged. Regularly inspect the SoClean 3 for physical damage, such as cracks or broken structure, damaged gaskets, and cracks in the Ozone Tube or sleep equipment hose. Discontinue use if damage is detected and contact SoClean for assistance.

REPLACING THE FILTER

The Filter must be replaced approximately every 6 months depending on usage. The Filter Issue icon  will flash **amber** to remind you to change your Filter. **The device will no longer operate a Maintenance Cycle if the Filter replacement warning expires and turns solid amber before the Filter is replaced.**

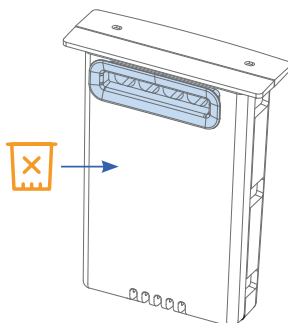

REORDERING PARTS OR ACCESSORIES

To reorder supplies, contact your authorized reseller or visit SoClean.com.

Beware of lookalike or counterfeit filters that may potentially damage your SoClean machine and void the warranty.

Authentic SoClean filter packaging includes labeling with part number, lot number, expiration date, and confirmation of SoClean as the manufacturer. Making sure your purchase includes this information can ensure you are purchasing an authentic filter guaranteed to work correctly with your SoClean machine.

When shopping on SoClean.com, you are assured of fully warranted, genuine SoClean replacement parts. You can also choose from many other useful products, accessories, and replacement parts.

For any questions about the authenticity of a filter, contact SoClean Customer Care.

Your SoClean 3 device has been designed to work only with authentic SoClean 3 Filters. You will not be able to operate your SoClean system with an inauthentic SoClean 3 Filter.

The manufacturer is not responsible for device malfunction or accidents caused by the use of inauthentic parts or accessories.

Part Name	SKU	Description
Ozone Tube	PN1404-3	This tube is what circulates ozone or air through your sleep equipment hose and mask during the Maintenance Cycle and Fresh Air Cycle.
Filter	PN1407	The Filter converts ozone in your SoClean 3 and sleep equipment hose and mask into fresh oxygen as it exhausts from the unit. This component must be replaced at least every 6 months and your SoClean 3 reminds you when it needs replacement.
Power Supply	PN1422-IP22	Used to power your SoClean 3.

General Troubleshooting

PROBLEM	YOU SEE	POSSIBLE CAUSES	SOLUTIONS	
The warning sign appears and all three buttons flash three times		Your device has not been activated	Complete steps on page 26.	
SoClean 3 will not operate a Maintenance Cycle or Fresh Air Cycle		This icon is solid amber on the Control Panel	<p>There may be an issue with the sleep equipment hose detection.</p> <p>The Lid may not be closed.</p> <p>Your sleep equipment hose may be incompatible.</p>	<p>Check that your sleep equipment hose has been properly placed into the Hose Slot and the Lid is fully closed.</p> <p>Check to see if the Lid is fully closed.</p> <p>Some sleep equipment hoses may not be compatible with your SoClean 3. Contact SoClean Customer Care.</p>
		This icon is flashing amber on the Control Panel	<p>The SoClean 3 is in the process of detecting the hose status.</p> <p>User attempted to defeat the hose Detect feature.</p> <p>It's the first time SoClean 3 was powered on or there was a loss of power to the device.</p>	<p>Wait a few seconds for the hose to be detected. If the hose is not detected, the light will turn solid amber.</p> <p>Do not attempt to defeat the Hose Detect feature.</p> <p>Open and close Lid.</p>
		This icon is solid amber on the Control Panel	The Filter door may be open.	Open and securely close the Filter door.
This icon is flashing amber when starting a Maintenance or Fresh Air Cycle		This icon is solid amber on the Control Panel	The Filter is expired or counterfeit Filter is installed.	Replace with a new genuine Filter.
		This icon is flashing amber on the Control Panel	Time to order a new Filter.	Order a replacement Filter. (See page 17 for details.)

PROBLEM

YOU SEE

POSSIBLE CAUSES

SOLUTIONS

SoClean 3 will not operate a Maintenance Cycle or Fresh Air Cycle

 This icon is solid **red** on the Control Panel and the device is not running.

There may be an internal device issue.

Unplug your SoClean 3 from its power source and contact SoClean Customer Care.

None of the lights illuminate, even when you press buttons

The SoClean 3 may not be connected to power.

Check that the Power Supply is plugged in correctly into the back of the SoClean 3 and the AC wall outlet. If the issue persists, contact SoClean Customer Care.

The SoClean 3 is making a noise and these indicators are illuminated red on the control panel

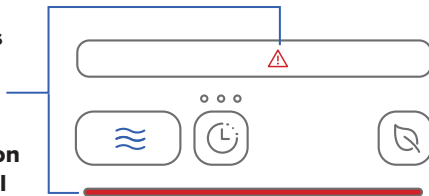

NOTE: These icons may or may not be illuminated on the Control Panel.

Your SoClean 3 was operating a Maintenance Cycle and one of the following occurred:

- Power to the SoClean 3 was momentarily lost
- Lid was forced opened
- The sleep equipment hose was not detected after the Maintenance Cycle started
- Internal Device Issue

Your SoClean 3 is pumping air through the system to remove ozone and allow you to access your sleep equipment mask and hose. Allow this process to complete. You can either remove your mask and hose for use or start a new Maintenance Cycle when the green Cycle Complete icon appears.

NOTE: Your sleep equipment mask and hose may not have been fully maintained before this issue occurred.

Wait a minimum of 30 minutes between completion of the Cycle and use of the sleep equipment mask and hose.





SoClean 3 will not operate a Fresh Air Cycle



Fresh Air button flashes when pressed.

You have run 3 consecutive Fresh Air Cycles.

Run a Maintenance Cycle.

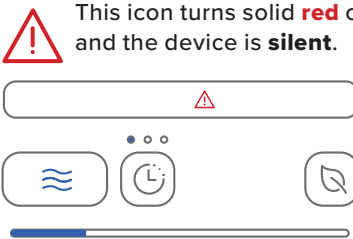
PROBLEM	YOU SEE	POSSIBLE CAUSES	SOLUTIONS
<p>Lid does not open when the Lid Open button is pressed</p>	 <p>These icons are illuminated blue on the Control Panel.</p>	<p>The Maintenance Cycle is running.</p>	<p>The Lid is locked during a Maintenance Cycle. To cancel the cycle, press the Lid Open button for approximately 5 seconds. The Fault/Unable to Run icon  will flash red at the start of the cancellation. It will take approximately 15 minutes before you can access your sleep equipment mask and hose.</p> <p>Wait a minimum of 30 minutes between completion of the Cycle and use of the sleep equipment mask and hose.</p>
	 <p>No buttons light up.</p>	<p>Your SoClean 3 may not be connected to power.</p>	<p>Check that the Power Supply is plugged into the wall and the back of the device.</p>
	 <p>You hear a click and the buttons light up blue but the Lid doesn't open.</p>	<p>The Lid may be stuck.</p>	<p>After you press the Lid Open button and hear the click, pull up gently on your sleep equipment hose to assist in opening the Lid.</p>
<p>Lid does not open and you are unable to access your sleep equipment mask and hose when the Lid Open button is pressed</p>	 <p>This icon turns solid red on the Control Panel and the device is silent.</p> <p>NOTE: These icons may or may not be illuminated on the Control Panel.</p> <p>The progress bar will slowly illuminate blue over a 2 hour time period similar to a Maintenance Cycle.</p>	<p>Pump and fan may have failed.</p>	<p>Lid will unlock after 2 hours allowing the ozone to break down prior to removing your sleep equipment hose and mask.</p> <p>Contact SoClean Customer Care.</p> <p>Wait a minimum of 30 minutes between completion of the Cycle and use of the sleep equipment mask and hose.</p>

PROBLEM	YOU SEE	POSSIBLE CAUSES	SOLUTIONS
Delayed Maintenance Cycle did not start	 <p>None of the delay indicators are illuminated blue.</p>	<p>Cycle Delay button may have been pressed an additional time, resetting it to No Delay.</p> <p>Maintenance Cycle button was not pressed after setting a Cycle Delay.</p>	<p>Be sure to leave one second between presses and do not press again after the initial setting unless you intend to cancel the Cycle Delay.</p> <p>See instructions on page 30 for setting a Cycle Delay.</p>
There is a noticeable odor of ozone or unfamiliar odor or you experience headaches/migraines, or symptoms such as cough or discomfort in your nose or throat during Maintenance Cycle of your SoClean 3	<p>SoClean 3 appears to operate normally.</p>	<p>There may be physical damage to your SoClean 3.</p> <p>The ozone tube may be disconnected.</p>	<p>Leave the room for 4 hours</p> <p>Contact SoClean Customer Care before running your machine again..</p>
There is a noticeable scent in your mask after using SoClean 3	<p>SoClean 3 appears to operate normally.</p>	<p>Your mask and hose may contain fragrance or impurities.</p>	<p>Use the Fresh Air Cycle.</p> <p>Regularly wash your hose and mask according to the manufacturer's instructions.</p> <p>Use unscented sleep equipment wipes after Maintenance Cycle.</p>
Your mask is discoloring	<p>SoClean 3 appears to operate normally.</p>	<p>Washing your hose and mask may not be taking place.</p> <p>It may be time to replace your mask.</p>	<p>Wash, rinse and dry your hose and mask the way the manufacturer recommends.</p> <p>Replace your sleep equipment mask at the manufacturer's recommended interval.</p>
You're developing a rash where the mask touches your face		<p>Regular hand washing of your hose and mask may not be taking place.</p> <p>Skincare or beauty products on the mask may not interact well with ozone.</p>	<p>Discontinue use of the SoClean 3.</p> <p>Consult your healthcare provider.</p> <p>Contact SoClean Customer Care.</p> <p>Regularly wash your hose and mask according to the manufacturer's instructions.</p> <p>Use unscented sleep equipment wipes to clean your mask before and after the Maintenance Cycle.</p>

Warranty Information

SoClean Inc. warrants this product, **SoClean 3**, non-inclusive of replacement parts, under a two (2) year limited warranty for defects in manufacture or workmanship.

For all warranty issues, a return authorization number and proof of purchase is required. Please contact SoClean at SoClean.com. Returned products must be shipped prepaid and insured. CODs are not accepted. Products repaired or replaced under warranty will not incur reshipping charges. Under this warranty, the sole remedy shall be repair or replacement at SoClean's discretion.

IMPORTANT: To ensure authenticity, filters must be purchased directly from SoClean or from an authorized reseller store or website. **Your SoClean 3 device has been designed to work only with genuine SoClean 3 Filters. You will not be able to operate your SoClean System with an inauthentic SoClean 3 Filter.** Warranties will be voided if the product is used with an inauthentic Filter and not replaced in accordance with usage instructions.

LIMITATION DAMAGES: SOCLEAN SHALL NOT BE LIABLE FOR ANY INCIDENTAL OR CONSEQUENTIAL DAMAGES FOR BREACH OF ANY EXPRESS OR IMPLIED WARRANTY ON THIS PRODUCT.

NO LIABILITY ARISING FROM ITS USE, HOWEVER, CAN BE ACCEPTED BY THE COMPANY, WHO RESERVES THE RIGHT, WITHOUT PRIOR NOTICE, TO ALTER THE SPECIFICATIONS, CONSTRUCTION, OR CONTENT OF ITS EQUIPMENT AT THE COMPANY'S OWN DISCRETION.

For further questions or concerns, visit our website: **SoClean.com**

Call: **866-501-3705**

WARRANTY REGISTRATION



Two ways to register

1. Online at SoClean.com/warranty
2. Complete the form below.

Mail this form to: SoClean Inc., ATTN: Warranty Registration, 1 Vose Farm Road, Peterborough, NH 03458

Name _____

Address _____

City/State/Zip _____ Phone _____

Email _____ Date Purchased _____

Serial Number

S	C	1	4	0	0														
---	---	---	---	---	---	--	--	--	--	--	--	--	--	--	--	--	--	--	--

 Look for the **SN** symbol on the bottom of the unit and enter the number beginning with SC1400 as shown in the sample image:



Purchased From: Direct from SoClean In a store Amazon Received as a gift Other _____

Which sleep equipment model do you use with your SoClean? _____

Yes! I would like to receive future discounts and tips for a healthier lifestyle.

PLEASE PROVIDE PROOF OF PURCHASE IF YOU DID NOT BUY YOUR SOCLEAN FROM US.



Thank you for purchasing the SoClean 3.

Please read this entire manual carefully before using your SoClean 3 and keep it for future reference.

Questions? ¿Preguntas?

 [SoClean.com/contact](https://www.soclean.com/contact)

 **866-501-3705**

For warranty information, visit [SoClean.com/warranty](https://www.soclean.com/warranty)

Copyright © 2011-2023

SoClean® is a registered trademark of SoClean, Inc.
1 Vose Farm Road, Peterborough, NH 03458, U.S.A.
Patent: [SoClean.com/patents](https://www.soclean.com/patents)