

SoClean®

ADAPTER FOR HOSE AND MASK MAINTENANCE COMPATIBLE WITH MOST CPAP HOSES

1 - SoClean Adapter



2 - Hose Sleeves
[For use with 12 mm hose]

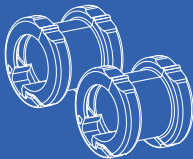

INSTRUCTIONS FOR USE
PNA1604-23-EU

If you need help connecting your adapter, contact SoClean.

For SoClean operation information, please see the User Manual provided with the device.

An electronic version of the User Manual is available at SoClean.com or you may contact Customer Care.

IMPORTANT: This adapter needs to fit snugly. If the fit appears too tight, do not force adapter into tubing. If the adapter is loose, call Customer Care.

00800 5558 8811 | SoClean.com
info@soclean.com

Installation Instructions



SoClean Adapter



Shown
connected to
popular CPAP
hoses.

If you are a **SoClean 3** user, move on to **Step 1**.



If you are a **SoClean 2** user:

Detach **Ozone Tube** from **Injection Fitting** or your previous **SoClean Adapter**. Save **Injection Fitting** in case you need it in the future.

Move on to Step 1.

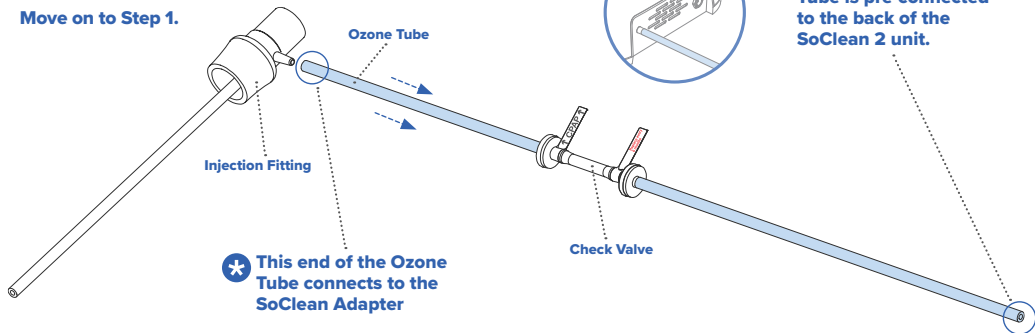

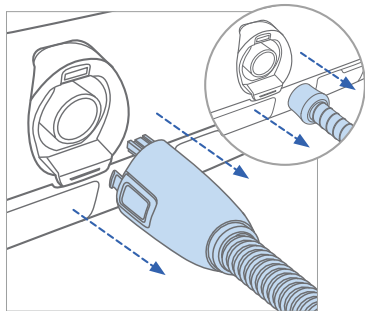

1

Remove the hose from your sleep equipment.

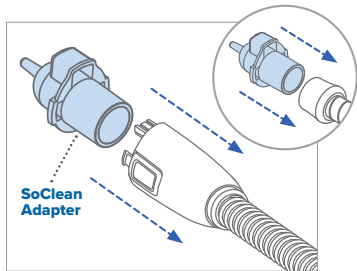

2

Install the SoClean Adapter onto the hose.

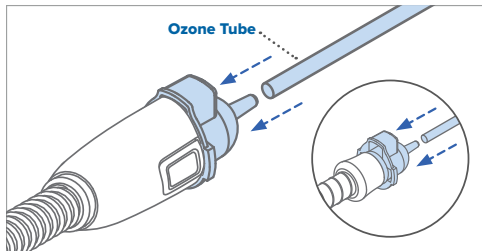

3

Connect **Ozone Tube** to the **SoClean Adapter**. You are now ready to use your SoClean.

Place mask into the **SoClean Chamber** and run the maintenance cycle.

NOTE: SoClean is not responsible for damage to your sleep equipment machine or personal property resulting from equipment mishandling.



WARNING: The **Ozone Tube** should always be connected to the **SoClean Adapter** and the back of the SoClean unit when operating the SoClean.

Sleep Equipment Hose Compatibility

For use with hose diameters of 15 mm and 19 mm and length up to 6' 6".

A 12 mm hose diameter will require a SoClean Hose Sleeve.

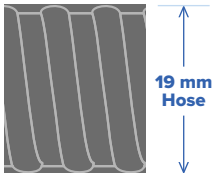
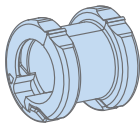

The images shown are actual size and can be used to determine which hose you have.

If you determine you require the Hose Sleeve, contact SoClean Customer Care or your authorized reseller.

Reconnecting Your Sleep Equipment

Once the **Maintenance Cycle** is complete and you are ready to use your sleep equipment:

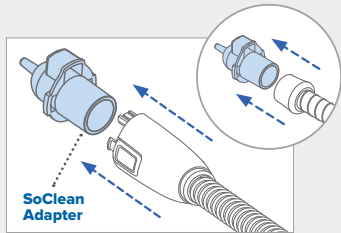

1

Remove the **SoClean Adapter** from your hose.

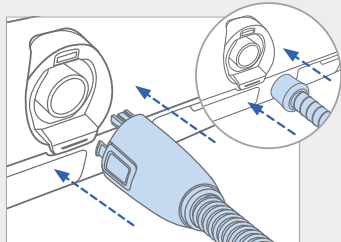

2

Reconnect your hose to the sleep equipment hose port.

Using Your SoClean

The below images show both SoClean devices connected.



Once you have completed the setup steps, you are ready to begin the daily maintenance of your sleep equipment accessories with your SoClean.

Safety Checklist Before Using Your SoClean

- Sleep equipment accessories are washed in sink and dried before first use
- SoClean Adapter is installed on sleep equipment hose
- Ozone tube is connected to the SoClean Adapter
- Sleep equipment hose is still connected to the mask
- SoClean is powered on
- Filter is installed



DEUTSCH

SoClean®

ADAPTER FÜR SCHLAUCH- UND
MASKENWARTUNG

KOMPATIBEL MIT DEN MEISTEN CPAP-SCHLÄUCHEN

1 – SoClean-Adapter 2 – Schlauchmanschetten
[Zur Verwendung mit
12-mm-Schlauch]

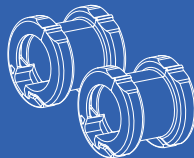

GEBRAUCHSANWEISUNG

PNA1604-23-EU

Wenn Sie Hilfe beim Anschließen Ihres Adapters benötigen, wenden Sie sich an SoClean.

Informationen zur Bedienung des
SoClean finden Sie im beiliegenden
Benutzerhandbuch des Geräts.

Eine elektronische Version des
Benutzerhandbuchs ist unter SoClean.com
verfügbar. Alternativ können Sie sich auch
an den Kundendienst wenden.

WICHTIG: Dieser Adapter muss gut sitzen.
Wenn der Adapter zu fest sitzt, den Adapter
nicht mit Gewalt in den Schlauch drücken.
Wenn der Adapter locker ist, wenden Sie sich
an den Kundendienst.

00800 5558 8811 | SoClean.com
info@soclean.com

Montageanleitung



SoClean-Adapter



Wenn Sie **SoClean 3** verwenden,
fahren Sie mit **Schritt 1** fort.



Wenn Sie **SoClean 2** verwenden:

Lösen Sie die **Ozonröhre** vom **Einspritzanschlussstück**
oder Ihrem bisherigen **SoClean-Adapter**. Bewahren Sie das
Einspritzanschlussstück für einen möglichen Gebrauch zu einem
späteren Zeitpunkt auf.

Fahren Sie mit **Schritt 1** fort.

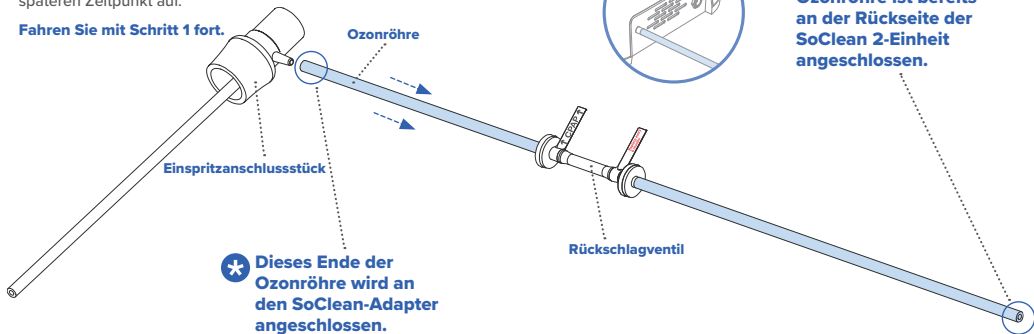

* Dieses Ende der
Ozonröhre wird an
den SoClean-Adapter
angeschlossen.

* Dieses Ende der
Ozonröhre ist bereits
an der Rückseite der
SoClean 2-Einheit
angeschlossen.

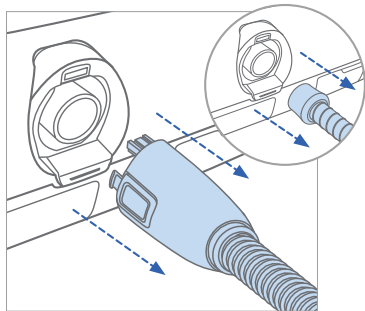

1

Entfernen Sie den Schlauch von Ihrem Schlafgerät.

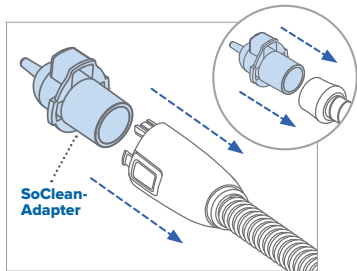

2

Montieren Sie den SoClean-Adapter am Schlauch.

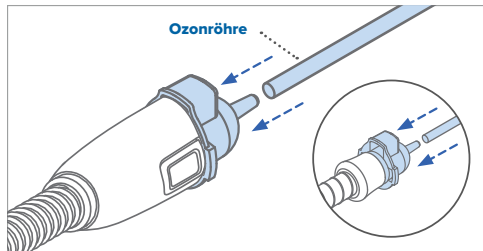

3

Schließen Sie die **Ozonröhre** an den **SoClean-Adapter** an. Das SoClean-Gerät ist jetzt einsatzbereit.

Setzen Sie die Maske in die **SoClean-Kammer** ein und führen Sie den Wartungszyklus durch.

HINWEIS: SoClean haftet nicht für Schäden an Ihrem Schlafgerät oder persönlichem Eigentum, die durch unsachgemäßen Umgang mit dem Gerät verursacht werden.



WARNUNG: Die **Ozonröhre** muss bei Betrieb des SoClean-Geräts immer an den **SoClean-Adapter** und die Rückseite der SoClean-Einheit angeschlossen sein.

Schlauchkompatibilität für Schlafgeräte

Für den Einsatz mit Schlauchdurchmessern von 15 mm und 19 mm und einer Länge von bis zu 198 cm.

Bei einem Schlauchdurchmesser von 12 mm ist eine SoClean-Schlauchmanschette erforderlich.

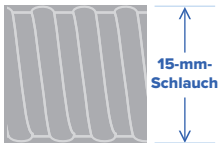
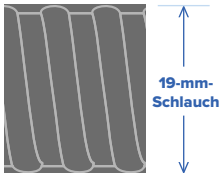
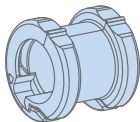

Die Abbildungen zeigen die tatsächliche Größe und können zur Bestimmung der Größe der eigenen Schläuche verwendet werden.

Wenn Sie feststellen, dass Sie eine Schlauchmanschette benötigen, wenden Sie sich an den SoClean-Kundendienst oder Ihren Händler.

Erneutes Anschließen Ihrer Schlafgeräte

Wenn der **Wartungszyklus** abgeschlossen ist und Sie Ihr Schlafgerät verwenden möchten:

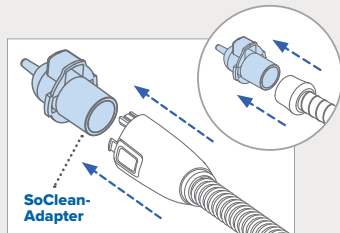

1

Entfernen Sie den **SoClean-Adapter** von Ihrem Schlauch.

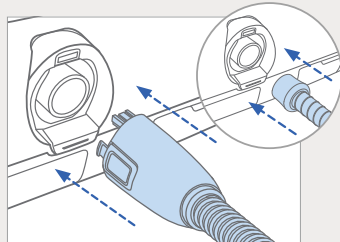

2

Schließen Sie den Schlauch wieder an den Schlauchanschluss des Schlafgeräts an.

Verwendung des SoClean-Geräts

Die folgenden Bilder zeigen den richtigen Anschluss beider SoClean-Geräte.



Sobald Sie die Einrichtungsschritte abgeschlossen haben, können Sie mit der täglichen Wartung des Zubehörs Ihres Schlafgeräts mit Ihrem SoClean-Gerät beginnen.

Sicherheitscheckliste vor der Verwendung des SoClean-Geräts

- Das Zubehör des Schlafgeräts wurde vor der ersten Verwendung im Waschbecken gewaschen und anschließend getrocknet.
- Der SoClean-Adapter ist am Schlauch des Schlafgeräts angebracht.
- Die Ozonröhre ist am SoClean-Adapter angeschlossen.
- Der Schlauch des Schlafgeräts ist weiterhin an die Maske angeschlossen.
- Das SoClean-Gerät ist eingeschaltet.
- Der Filter ist installiert.



ESPAÑOL

SoClean®

ADAPTADOR PARA MANTENIMIENTO DE MANGUERA Y MÁSCARA

COMPATIBLE CON LA MAYORÍA
DE MANGUERAS CPAP

1 - Adaptador SoClean

2 - Manguitos de manguera
[Para uso con manguera de 12 mm]

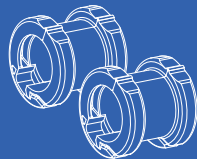

INSTRUCCIONES DE USO

PNA1604-23-EU

Si necesita ayuda para conectar el adaptador, póngase en contacto con SoClean.

Para obtener información sobre el funcionamiento de SoClean, consulte el manual de usuario suministrado con el dispositivo.

Hay disponible una versión electrónica del manual del usuario en SoClean.com o puede ponerse en contacto con el servicio de atención al cliente.

IMPORTANTE: El adaptador debe ajustarse perfectamente. Si el ajuste parece demasiado apretado, no fuerce el adaptador en el tubo. Si el adaptador está suelto, llame al servicio de atención al cliente.

00800 5558 8811 | SoClean.com
info@soclean.com

Instrucciones de instalación



Adaptador SoClean



Si es usuario de SoClean 3, vaya al paso 1.



Si es usuario de SoClean 2:

Desconecte el **tubo de ozono** del accesorio de **colocación de inyección** o del **adaptador SoClean** anterior. Guarde el accesorio de **colocación de inyección** por si lo necesita en el futuro.

Vaya al paso 1.

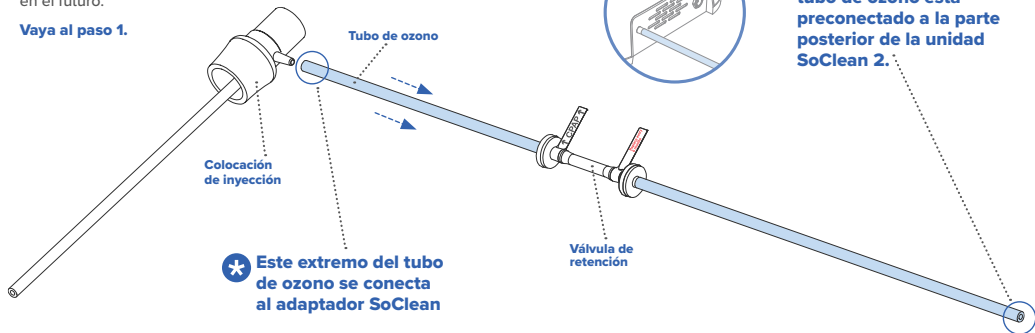

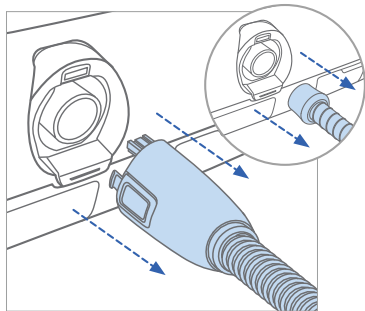

1

Retire la manguera de descanso.

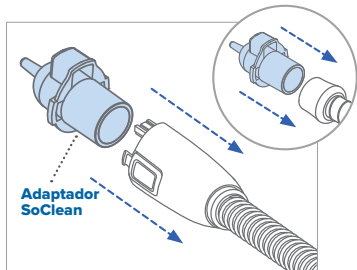

2

Instale el adaptador SoClean en la manguera.

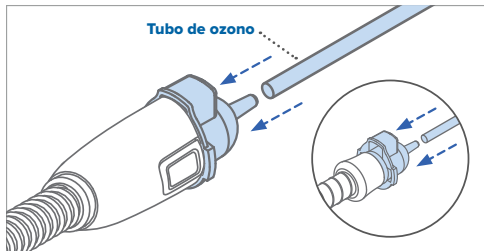

Tubo de ozono

3

Conecte el **tubo de ozono** al **adaptador SoClean**. Ya está listo para utilizar el sistema SoClean.

Coloque la mascarilla en la **cámara SoClean** y ejecute el ciclo de mantenimiento.

NOTA: SoClean no se hace responsable de los daños en la máquina del equipo de descanso ni en la propiedad personal que se produzcan como consecuencia de una manipulación incorrecta del equipo.



ADVERTENCIA: El **tubo de ozono** debe estar siempre conectado al **adaptador SoClean** y a la parte posterior de la unidad SoClean cuando utilice el SoClean.

Compatibilidad de las mangueras con los equipos de descanso

Para usar con diámetros de manguera de 15 y 19 mm y longitudes de hasta 1,98 m.

Una manguera de 12 mm de diámetro requerirá un manguito de manguera SoClean.

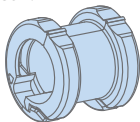

Las imágenes mostradas son de tamaño real y se pueden utilizar para determinar qué manguera tiene.

Si determina que necesita el manguito para tubos flexibles, póngase en contacto con el servicio de atención al cliente de SoClean o con su distribuidor autorizado.

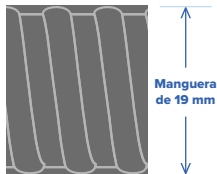

Reconexión del equipo de descanso

Una vez que haya finalizado el **ciclo de mantenimiento** y esté listo para utilizar el equipo de descanso:

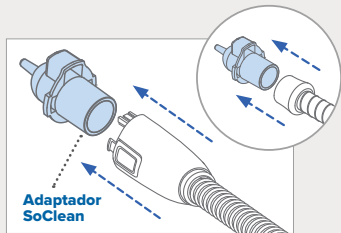

1

Retire el **adaptador SoClean** de la manguera.

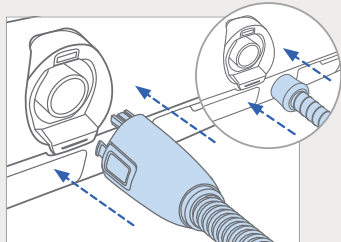

2

Vuelva a conectar la manguera en el puerto de la manguera del equipo de descanso.

Uso de su SoClean

Las siguientes imágenes muestran los dos dispositivos SoClean conectados.



Una vez que haya completado los pasos de configuración, estará listo para comenzar el mantenimiento diario de los accesorios del equipo de descanso con su SoClean.

Lista de comprobación de seguridad antes de utilizar el SoClean

- Los accesorios del equipo de descanso se lavan en el fregadero y se secan antes del primer uso
- El adaptador SoClean está instalado en la manguera del equipo de descanso
- El tubo de ozono está conectado al adaptador SoClean
- La manguera del equipo de descanso sigue conectada a la mascarilla
- SoClean está encendido
- El filtro está instalado



FRANÇAIS

SoClean®

ADAPTATEUR POUR L'ENTRETIEN
DU TUYAU ET DU MASQUE

COMPATIBLE AVEC LA PLUPART DES TUYAUX À PPC

1 – Adaptateur SoClean

2 – Manchons de tuyau

[À utiliser avec un tuyau de 12 mm]

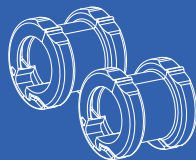

MODE D'EMPLOI

PNA1604-23-EU

Si vous avez besoin d'aide pour connecter votre adaptateur, contactez SoClean.

Pour plus d'informations sur le fonctionnement de SoClean, reportez-vous au manuel d'utilisation fourni avec l'appareil.

Pour obtenir une version électronique du manuel de l'utilisateur, rendez-vous sur le site SoClean.com ou contactez le service clientèle.

IMPORTANT : cet adaptateur doit être parfaitement ajusté. Si l'adaptateur semble trop serré, ne pas forcer son insertion dans le tuyau. Si l'adaptateur est desserré, appelez le service clientèle.

00800 5558 8811 | SoClean.com
info@soclean.com

Instructions d'installation



Adaptateur SoClean



Représenté
connecté à
des tuyaux à
PPC courants.

Si vous utilisez l'appareil **SoClean 3**, passez à l'étape 1.



Si vous utilisez l'appareil **SoClean 2** :

Détachez le **tube d'ozone** du **raccordement d'injection** ou de votre ancien **adaptateur SoClean**. Conservez le **raccordement d'injection** au cas où vous en auriez besoin à l'avenir.

Passez à l'étape 1.

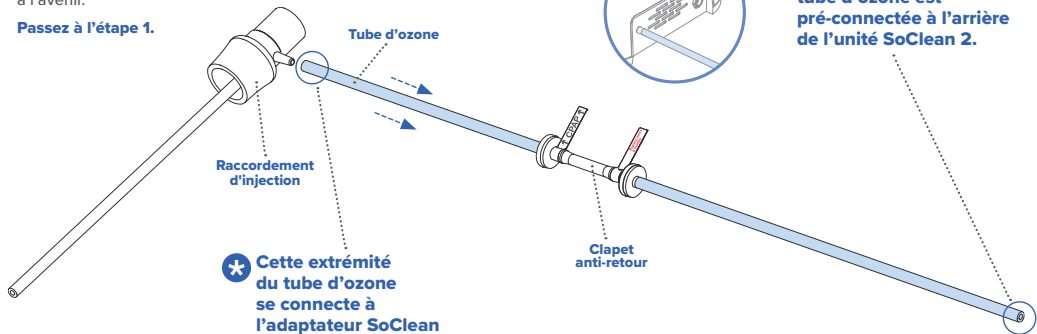

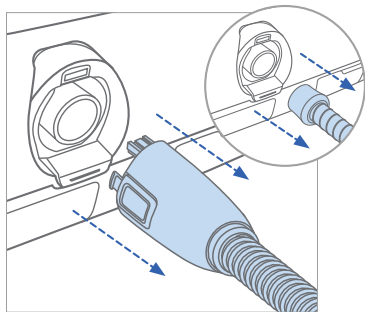

1

Retirez le tuyau de votre équipement de sommeil.

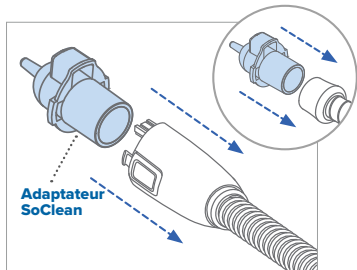

2

Installez l'adaptateur SoClean sur le tuyau.

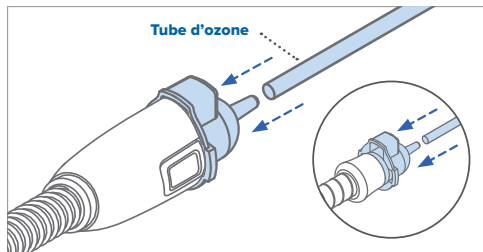

3

Connectez le **tube d'ozone** à l'**adaptateur SoClean**. L'appareil SoClean est désormais prêt à être utilisé.

Placez le masque dans le **réservoir SoClean** et lancez le cycle d'entretien.

REMARQUE : SoClean n'est pas responsable des dommages causés à votre équipement de sommeil ou à vos biens personnels suite à une manipulation inappropriée de l'équipement.



AVERTISSEMENT : le **tube d'ozone** doit toujours être connecté à l'**adaptateur SoClean** et à l'arrière de l'unité SoClean lorsque vous utilisez l'appareil SoClean.

Compatibilité des tuyaux de l'équipement de sommeil

À utiliser avec des tuyaux de 15 mm et 19 mm de diamètre et d'une longueur allant jusqu'à 198 cm.

Un tuyau de 12 mm de diamètre nécessite un manchon de tuyau SoClean.

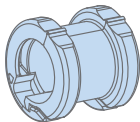

Les images présentées sont de taille réelle et peuvent être utilisées pour déterminer le tuyau dont vous disposez.

Si vous estimez avoir besoin du manchon de tuyau, contactez le service clientèle SoClean ou votre revendeur agréé.

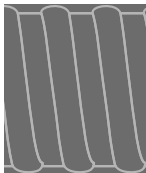

Tuyau de 19 mm

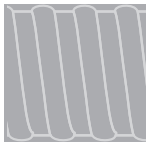

Tuyau de 15 mm



Tuyau de 12 mm

Reconnexion de votre équipement de sommeil

Une fois le **cycle d'entretien** terminé et que vous êtes prêt à utiliser votre équipement de sommeil :

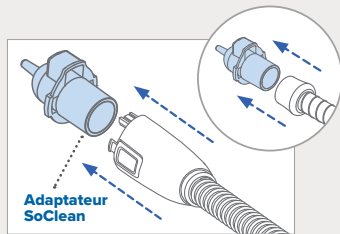

1

Retirez l'adaptateur SoClean du tuyau.

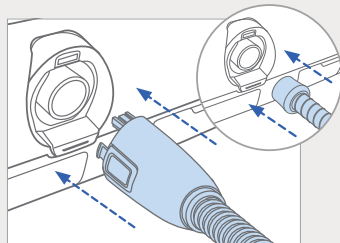

2

Reconnectez le tuyau à l'orifice dédié de l'équipement de sommeil.

Utilisation de votre appareil SoClean

Les images ci-dessous montrent les deux appareils SoClean connectés.

Une fois les étapes de configuration terminées, vous pouvez commencer la maintenance quotidienne des accessoires de votre équipement de sommeil ainsi que de votre appareil SoClean.



Liste de contrôle de sécurité avant d'utiliser votre appareil SoClean

- Les accessoires de l'équipement de sommeil doivent être lavés dans un évier et séchés avant la première utilisation
- L'adaptateur SoClean est installé sur le tuyau de l'équipement de sommeil
- Le tube d'ozone est connecté à l'adaptateur SoClean
- Le tuyau de l'équipement de sommeil est toujours connecté au masque
- L'appareil SoClean est sous tension
- Le filtre est installé



ITALIANO

SoClean®

ADATTATORE PER LA
MANUTENZIONE DI TUBI E MASCHERE

COMPATIBILE CON LA MAGGIOR PARTE DEI TUBI CPAP

- 1 – Adattatore SoClean 2 – Manicotti per tubi
[Per l'uso con tubo da 12 mm]

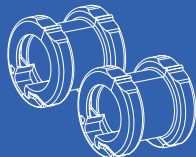

ISTRUZIONI D'USO
PNA1604-23-EU

Per assistenza per il collegamento dell'adattatore, contattare SoClean.

Per informazioni sul funzionamento del dispositivo SoClean, consultare il Manuale d'uso fornito con il dispositivo.

Una versione elettronica del Manuale d'uso è disponibile all'indirizzo SoClean.com. In alternativa, è possibile contattare l'assistenza clienti.

IMPORTANTE : questo adattatore deve avere un'aderenza perfetta. Se il raccordo risulta troppo stretto, non forzare l'adattatore nel tubo. Se l'adattatore è allentato, contattare l'assistenza clienti.

00800 5558 8811 | SoClean.com
info@soclean.com

Istruzioni per l'installazione



Adattatore SoClean



Mostrato
collegato ai
tubi CPAP più
diffusi.

Se si utilizza **SoClean 3**, procedere al **passaggio 1**.



Se si utilizza SoClean 2:

Staccare il **tubo dell'ozono** dal **raccordo per l'iniezione** o dall'**adattatore SoClean precedente**. Conservare il **raccordo per l'iniezione**; potrebbe essere necessario in futuro.

Procedere al passaggio 1.

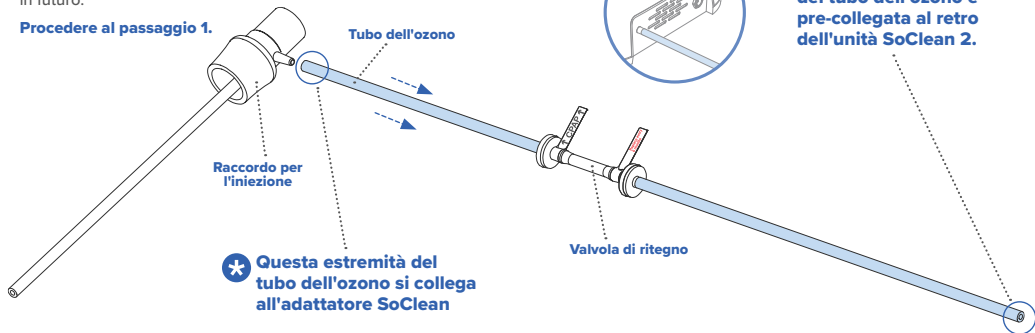

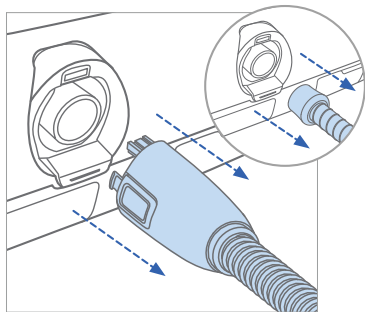
**1**

Rimuovere il tubo dall'apparecchiatura per il sonno.

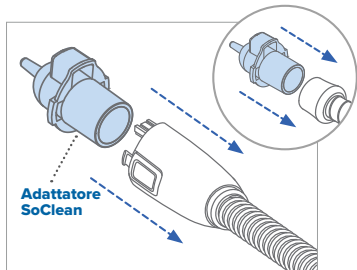
**2**

Installare l'adattatore SoClean sul tubo.

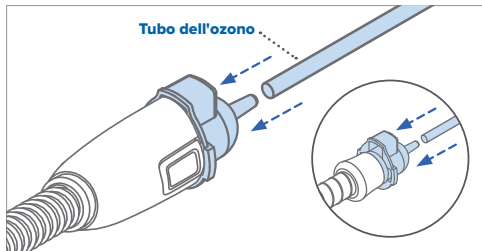
**Tubo dell'ozono****3**

Collegare il **tubo dell'ozono** all'**adattatore SoClean**. A questo punto è possibile utilizzare il dispositivo SoClean.

Posizionare la maschera nella **camera SoClean** ed eseguire il ciclo di manutenzione.

NOTA: SoClean non è responsabile di danni alla macchina per il sonno o alle proprietà personali derivanti da una manipolazione impropria dell'apparecchiatura.



AVVERTENZA: il **tubo dell'ozono** deve essere sempre collegato all'**adattatore SoClean** e al retro dell'unità SoClean durante il funzionamento del dispositivo SoClean.

Compatibilità dei tubi dell'apparecchiatura per il sonno

Per l'uso con tubi di diametro 15 mm e 19 mm e lunghezza fino a 198 cm.

Un tubo da 12 mm di diametro richiede un manicotto per tubo SoClean.

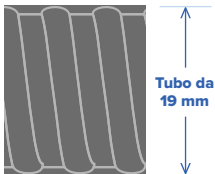
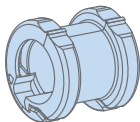

Le immagini mostrate sono di dimensioni reali e possono essere utilizzate per individuare il tubo di cui si dispone.

Qualora dovesse essere necessario un manicotto per tubo, contattare l'assistenza clienti SoClean o il proprio rivenditore autorizzato.

Ricollegare l'apparecchiatura per il sonno

Dopo aver completato il **ciclo di manutenzione** e si desidera utilizzare l'apparecchiatura per il sonno:

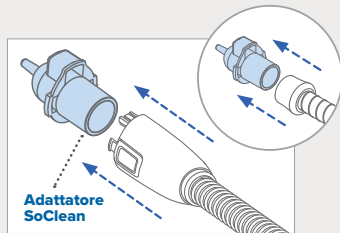

1

Rimuovere l'**adattatore SoClean** dal tubo.

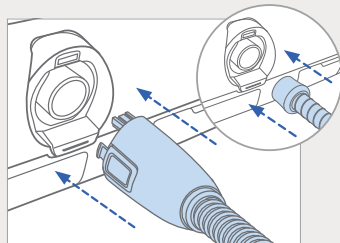

2

Ricollegare il tubo alla porta del tubo dell'apparecchiatura per il sonno.

Usare SoClean

Le seguenti immagini mostrano entrambi i dispositivi SoClean collegati.



Una volta completata la procedura di configurazione, è possibile iniziare la manutenzione giornaliera degli accessori dell'apparecchiatura per il sonno con il dispositivo SoClean.

Elenco di controllo di sicurezza prima di usare SoClean

- Gli accessori dell'apparecchiatura per il sonno sono stati lavati nel lavandino e asciugati prima del primo utilizzo
- L'adattatore SoClean è installato sul tubo dell'apparecchiatura per il sonno
- Il tubo dell'ozono è collegato all'adattatore SoClean
- Il tubo dell'apparecchiatura per il sonno è ancora collegato alla maschera
- SoClean è acceso
- Il filtro è installato



NEDERLANDS

SoClean®

ADAPTER VOOR ONDERHOUD
VAN SLANGEN EN MASKERS

COMPATIBEL MET DE MEESTE CPAP-SLANGEN

1 - SoClean-adapter

2 - Slanghouders

[Voor gebruik met een slang van 12 mm]

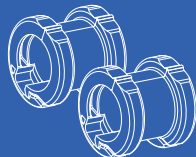

GEBRUIKSAANWIJZING

PNA1604-23-EU

Neem contact op met SoClean als u hulp nodig hebt bij het aansluiten van uw adapter.

Raadpleeg voor informatie over de werking van SoClean de gebruikershandleiding die bij het apparaat is geleverd.

Een elektronische versie van de gebruikershandleiding is beschikbaar op SoClean.com. U kunt ook contact opnemen met de klantenservice.

BELANGRIJK: deze adapter moet goed passen.

Als de passing te strak lijkt te zijn, mag u de adapter niet met kracht in de slang drukken.

Als de adapter los zit, neemt u contact op met de klantenservice.

00800 5558 8811 | SoClean.com
info@soclean.com

Installatie-instructies



SoClean-adapter



Weergegeven
als aangesloten
op populaire
CPAP-slangen.

Ga verder met **stap 1** als u **SoClean 3** gebruikt.



Als u de **SoClean 2** gebruikt:

Koppel de **ozonslang** los van de **injectiekoppeling** of uw vorige **SoClean-adapter**. Bewaar de **injectiekoppeling** voor het geval u deze in de toekomst nodig hebt.

Ga verder met **stap 1**.

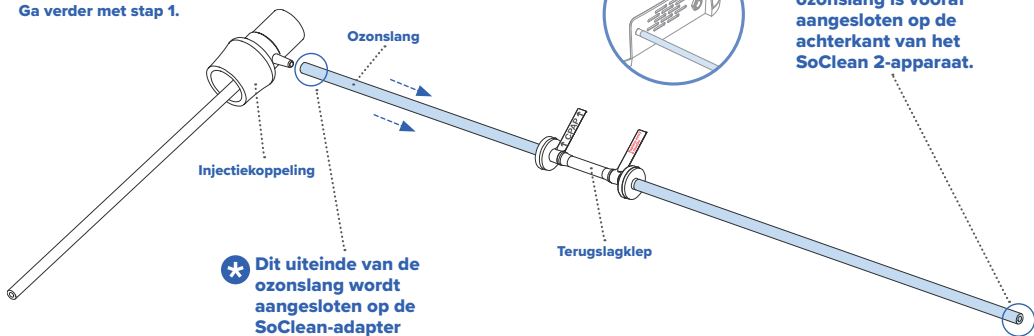

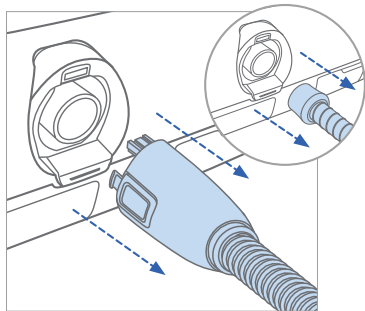

1

Verwijder de slang uit uw slaapparaat.

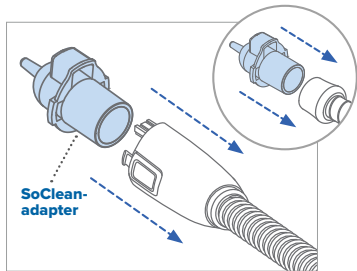

2

Breng de SoClean-adapter aan op de slang.

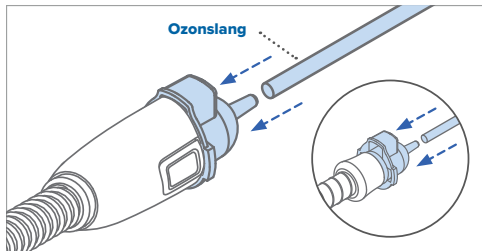

3

Sluit de **ozonslang** aan op de **SoClean-adapter**. U kunt uw SoClean nu gebruiken.

Plaats het masker in de **SoClean-kamer** en voer de onderhoudscyclus uit.

OPMERKING: SoClean is niet verantwoordelijk voor schade aan uw slaapparaat of persoonlijke eigendommen als gevolg van verkeerd gebruik van het apparaat.



WAARSCHUWING: de **ozonslang** moet altijd zijn aangesloten op de **SoClean-adapter** en de achterkant van het SoClean-apparaat wanneer u de SoClean gebruikt.

Compatibiliteit van slangen voor slaapparaatuur

Voor gebruik met slangdiameters van 15 mm en 19 mm en lengte tot 198 cm.

Voor een slangdiameter van 12 mm is een SoClean-slanghouder nodig.

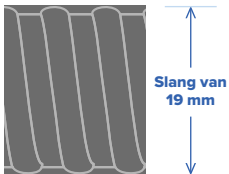
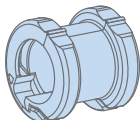

De getoonde afbeeldingen zijn werkelijke afmetingen en kunnen worden gebruikt om te bepalen welke slang u hebt.

Neem contact op met de klantenservice van SoClean of uw geautoriseerde wederverkoper als u hebt vastgesteld dat u de slanghouder nodig hebt.

Uw slaapparaatuur opnieuw aansluiten

Zodra de **onderhoudscyclus** is voltooid en u klaar bent om uw slaapparaatuur te gebruiken:

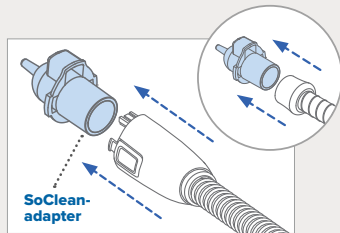

1

Verwijder de **SoClean-adapter** van de slang.

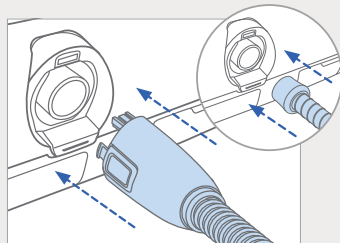

2

Sluit de slang opnieuw aan op de slangpoort van de slaapparaatuur.

Uw SoClean gebruiken

Op de onderstaande afbeeldingen zijn beide SoClean-apparaten aangesloten.



Zodra u de installatiestappen hebt voltooid, bent u klaar om het dagelijkse onderhoud van de accessoires van uw slaapparaat uit te voeren met de SoClean.

Veiligheidscontrolelijst vóór het gebruik van uw SoClean

- Accessoires van slaapparaat zijn gewassen in gootsteen en gedroogd vóór het eerste gebruik
- SoClean-adapter is op de slang van het slaapparaat geïnstalleerd
- Ozonslang is aangesloten op de SoClean-adapter
- Slang van slaapparaat is nog aangesloten op het masker
- SoClean is ingeschakeld
- Filter is geïnstalleerd



SoClean Inc.

12 Vose Farm Road | Peterborough, NH 03458
00800 5558 8811

SoClean.com/patents

Issue Date: 06/2022